

© EDWARDS SYSTEMS TECHNOLOGY, INC.

This product has been designed to meet the requirements of NFPA Standard 72, 1993 Edition; Underwriters Laboratories, Inc., Standard 864, 7th Edition; and Underwriters Laboratories of Canada, Inc., Standard ULC S527. Installation in accordance with this manual, applicable codes, and the instructions of the Authority Having Jurisdiction is mandatory.

EST, Inc. shall not under any circumstances be liable for any incidental or consequential damages arising from loss of property or other damages or losses owing to the failure of EST, Inc. products beyond the cost of repair or replacement of any defective products.

EST, Inc. reserves the right to make product improvements and change product specifications at any time.

The contents of this manual and the related software program are proprietary in nature and are intended solely for distribution to authorized persons, companies, distributors, and/or others for the sole purpose of conducting business associated with Edwards Systems Technology, Inc. The distribution of information contained with this manual to unauthorized persons shall constitute a violation of any distributor agreements and may require the implementation of legal proceedings.

**FCC WARNING**

This equipment can generate and radiate radio frequency energy. If this equipment is not installed in accordance with this manual, it may cause interference to radio communications. This equipment has been tested and found to comply within the limits for Class A computing devices pursuant to Subpart B of Part 15 of the FCC Rules. These rules are designed to provide reasonable protection against such interference when this equipment is operated in a commercial environment. Operation of this equipment is likely to cause interference, in which case the user at his own expense, will be required to take whatever measures may be required to correct the interference.

While every precaution was taken during the preparation of this manual to ensure the accuracy of its contents, EST assumes no responsibility for errors or omissions.

**USA**  
6411 Parkland Drive  
Sarasota, Florida  
USA 34243  
Tel: 941 739-4300  
Fax: 941 753-1806

**USA**  
90 Fieldstone Court  
Cheshire, Connecticut  
USA 06410-1212  
Tel: 203 699-3000  
Fax: 203 699-3075

**Canada**  
625 6<sup>TH</sup> Street East  
Owen Sound, Ontario  
Canada N4K 5P8  
Tel: 519 376-2430  
Fax: 519 376-7258

**International**  
201 City Centre Drive  
Suite 1105  
Mississauga, Ontario  
Canada L5B 2T4  
Tel: 905 270-1711  
Fax: 905 270-9553

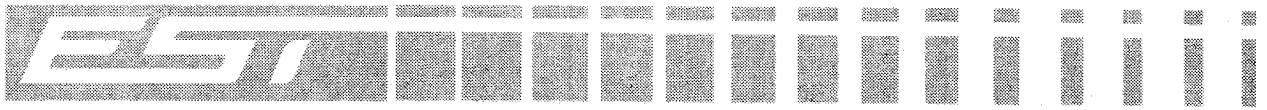

#### **FCC Information**

1. The dialer complies with Part 68 of the FCC rules. The Dialer' FCC registration number and the Ringer Equivalence Number (REN) are on the back of the dialer. This information must be provided to the telephone company, if requested.
2. An FCC compliant telephone cord and modular plug cord is supplied with the dialer. The dialer is designed to be connected to the telephone network using the supplied cord and an RJ31X or RJ38X jack, which must also comply with FCC Part 68 rules.
3. The REN is used to determine the quantity of devices which may be connected to the telephone line. Excessive RENs on the telephone line may result in the devices not ringing in response to an incoming call. In most, but not all areas, the sum of RENs should not exceed five (5). To be certain the number of devices that may be connected to a line, as determined by the total RENs, contact the local telephone company.
5. If the dialer causes harm to the telephone network, the telephone company will notify you in advance that temporary discontinuance of service may be required. If advance notice isn't practical, the telephone company will notify you as soon as possible. You will also be advised of your right to file a complaint with the FCC, if you believe it is necessary.
6. The telephone company may make changes in it's facilities, equipment, operations, or procedures that could affect the operation of the dialer. If this happens, the telephone company will provide advance notice in order for you to make necessary modifications to maintain uninterrupted service.
7. If trouble is experienced with the dialer, for repair or warranty information, contact Edwards Systems Technology, 6411 Parkland Drive, Sarasota, Florida, USA 34243 Telephone: 1-800-655-4497. If the dialer is causing harm to the telephone network, the telephone company may request you disconnect the dialer until the problem is resolved.
8. No repairs may be performed on the dialer by the user.
9. The dialer cannot be used on public coin phone or party line service provided by the telephone company.

#### **CANADA DOC Information**

**NOTICE:** The Canadian Department of Communications label identifies certified equipment. This certification means that the equipment meets certain telecommunications network protective, operational, and safety requirements. The Department does not guarantee the equipment will operate to the user's satisfaction

Before installing this equipment, users should ensure that is permissible to be connected to the facilities of the local telecommunications company. The equipment must also be installed using an acceptable method of connection. The customer should be aware that compliance with the above conditions may not prevent degradation of service in some situations.

Repairs to certified equipment should be made by an authorized Canadian maintenance facility designated by the supplier. Any repairs or alterations made by the user to this equipment, or equipment malfunctions, may give the telecommunications company cause to request the user disconnect the equipment.

Users should ensure for their own protection that the electrical ground connections of the power utility, telephone lines, and internal metallic water pipe system, if present, are connected together. This precaution may be particularly important in rural areas.

**Caution:** Users should not attempt to make such connections themselves, but should contact the appropriate electric inspection authority, or electrician, as appropriate

**NOTICE:** The Load Number (LN) assigned to each terminal device denotes the percentage of the total load to be connected to a telephone loop which is used by the device, to prevent overloading. The termination on a loop may consist of any combination of devices subject only to the requirements that the sum of the Load Numbers of all the devices does not exceed 100.

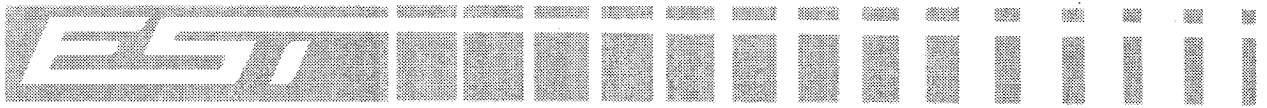

Effectivity Page for P/N 46000-1322, EST1 Manual

Revision	Description
0.0	Initial Release
0.1	Editorial Corrections
0.2	Add ADMM, ADSM, & RTU information
1.0	Revise product name to EST1. Revise module names. Added Table 1.2. Renamed Table 2.1 to Table 1.1.
1.1	Revised module names & part numbers.
1.3	Add EST1-2Z3-220 & EST1-2Z6-220; Add Table 10.12; Delete Table 5.9
1.4	Add Battery Box & revise battery tables; Revise 4-wire EOL Relay; Add Auxiliary Power note; Replace RCT with RCT-1; delete remote station from RCT-1 module; Add DL1 Dialer Module; add proprietary station wiring; Revise ADMM supervisory operation; add additional replacement parts.
1.5	Revised dialer and compatibility information

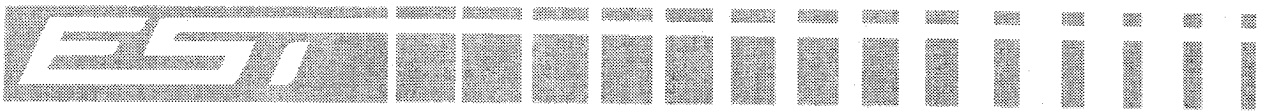

# Table of Contents



1.0 DESCRIPTION ..... 1-4  
 1.1 Components ..... 2



2.0 APPLICATION ..... 5  
 2.1 Fire Alarm System Limitations ..... 5



3.0 THEORY OF OPERATION ..... 5-8  
 3.1 Initiating Device Circuits (IDCs) ..... 5  
 3.2 Indicating Appliance Circuits (IACs) ..... 8



4.0 INSTALLATION ..... 9-16  
 4.1 Codes and Standards ..... 9  
 4.2 Site Storage ..... 9  
 4.3 Drawing References ..... 9  
 4.4 Installation Instructions ..... 10



5.0 PROGRAMMING ..... 17-21  
 5.1 Programming Initiating Device Circuits (IDCs) ..... 18  
 5.2 Programming Indicating Appliance Circuits (IACs) ..... 19  
 5.3 Configuring System Timers ..... 20  
 5.4 Programming Auxiliary Power ..... 20  
 5.5 Returning to Panel Default Settings ..... 21  
 5.6 Dialer Module ..... 21



6.0 OPERATION ..... 23-27  
 Normal Mode ..... 23  
 Alarm Mode ..... 23  
 Reset Mode ..... 24  
 Trouble Mode ..... 24  
 Supervisory Mode ..... 25  
 Drill Mode ..... 25  
 IDC Zone Disable ..... 25  
 Test Mode ..... 26  
 Dialer Module ..... 27  
 Remote Trouble Unit ..... 27

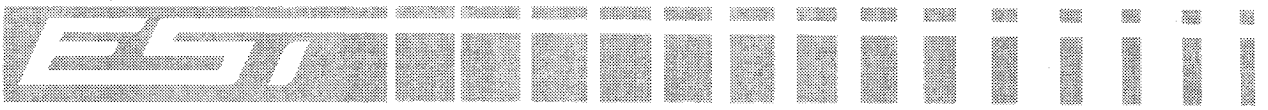

7.0 TROUBLESHOOTING .....28



8.0 PREVENTIVE MAINTENANCE..... 30-33

- 8.1 Preventive Maintenance Schedule.....30
- 8.2 Testing Procedures for the Dialer Module.....32
- 8.3 Testing Procedures for Compatible 2-Wire Smoke Detectors .....32
- 8.4 Replacement Parts.....33



9.0 SPECIFICATIONS..... 34-37



10.0 APPENDICES ..... 38-63

- 10.1 Appendix 1 - Battery Calculations .....38
  - Battery Tables .....38
  - Example 1 .....39
  - Example 2 .....40
  - Battery Calculation Worksheets .....41
  - Example 3 .....42
  - Example 4 .....43
- 10.2 Appendix 2 - Compatible Devices .....44
  - ULI Compatibility Listings .....44
  - ULC Compatibility Listings .....48
- 10.3 Appendix 3 - Glossary .....53
- 10.4 Appendix 4 - Standards Relevant to the Installation of this Product .....55
- 10.5 Appendix 5 - Fire Alarm Trouble & Maintenance Log .....56
- 10.6 Appendix 6 - Panel Configuration & Programming Worksheet .....57
- 10.7 Appendix 7 - EST Offices .....60
- 10.8 Appendix 8 - EST Catalog-to-P/N Cross Reference .....63

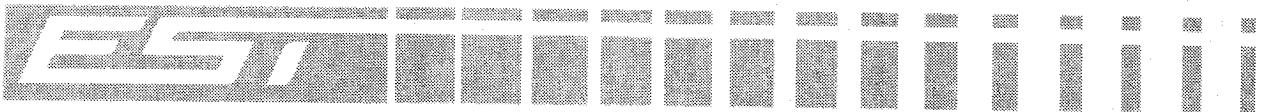

## List of Tables, Figures, & Illustrations

Table 1.1	Base Panel Capacity .....	2
Table 1.2	RCT-1 Battery Standby Requirements .....	3
Table 3.1	IDC Operation.....	5
Table 4.1	Drawing References .....	9
Table 5.1	Programmable Features.....	17
Table 5.2	Programming Step Indications .....	18
Table 5.3	IDC Zone Type Codes.....	18
Table 5.4	Panel Indicating Appliance Circuit Status.....	19
Table 5.5	IAC Signal Output Rates .....	19
Table 5.6	Alarm Silence Inhibit Timer Status.....	20
Table 5.7	Automatic Alarm Silence Timer Status .....	20
Table 5.8	Auxiliary Power on Reset Status .....	20
Table 6.1	Panel Indicators.....	23
Table 6.2	Test Mode.....	26
Table 6.3	Dialer Module LED Indicators .....	27
Table 7.1	Trouble LEDs.....	28
Table 7.2	Panel Trouble .....	28
Table 7.3	Dialer Module Trouble Codes.....	29
Table 8.1	Preventive Maintenance Schedule .....	30-31
Table 8.2	Related/Spare Parts .....	33
Table 9.1	Specifications (Base Panel Assemblies, BPA) .....	34
Table 9.2	Specifications (BPAC Base Panel Class A (Style D/Z) Converter Module).....	35
Table 9.3	Specifications (2IDC IDC Module) .....	35
Table 9.4	Specifications (IDCA IDC Class A (Style D) Zone Converter Module) .....	35
Table 9.5	Specifications (RCT-1 Relay/City-Tie Module) .....	35
Table 9.6	Specifications (ADMM Annunciator Driver Master Module).....	36
Table 9.7	Specifications (ADSM Annunciator Driver Slave Module) .....	36
Table 9.8	Specifications (Remote Annunciators).....	36
Table 9.9	Specifications (BC-2 Battery Box) .....	36
Table 9.10	Specifications (Dialer Module) .....	37
Table 10.1	24 Hours Supervisory, 5 Minutes of Alarm.....	38
Table 10.2	24 Hours Supervisory, 30 Minutes of Alarm.....	38
Table 10.3	60 Hours Supervisory, 5 Minutes of Alarm.....	39
Table 10.4	ULI Control Unit Compatibility Specifications - EST .....	44
Table 10.5	ULI Compatible Receivers for DL1 Dialer.....	44
Table 10.6	ULI Device & Panel Compatibility - Initiating Devices .....	45
Table 10.7	ULI Compatibility Signaling Appliances .....	46
Table 10.8	ULI Compatibility Accessories.....	47

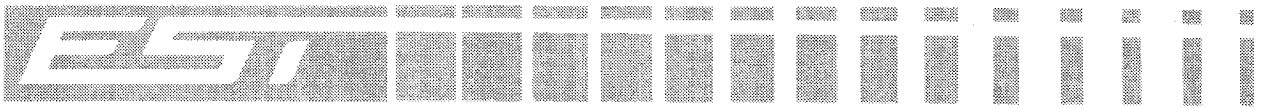
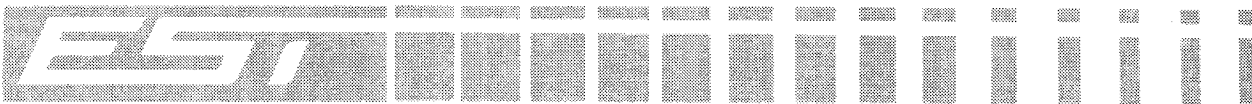

Table 10.9 ULC Control Unit Compatibility Specification - EST .....48  
 Table 10.10 ULC Compatible Receivers for DL1 Dialer .....48  
 Table 10.11 ULC Device & Panel Compatibility - Initiating Devices .....49  
 Table 10.12 ULC Compatible Signaling Appliances .....50  
 Table 10.13 ULC Compatible Accessories .....51  
 Table 10.14 Mixed Ion/Photo Detector Maximum Devices per Circuit .....52

Figure 3.1 Unsustained Alarm Operation .....7  
 Figure 3.2 Verified Alarm Operation .....7  
 Figure 3.3 IAC Signal Rates .....8

Drawing #1..... **CONTROL PANEL INSTALLATION 1**  
 Drawing #2..... **CONTROL PANEL INSTALLATION 2**  
 Drawing #3..... **CONTROL PANEL**  
 Drawing #4..... **INITIATING DEVICE CIRCUIT WIRING**  
 Drawing #5..... **RELAY/CITY-TIE MODULE**  
 Drawing #6..... **DIALER**  
 Drawing #7..... **REMOTE ANNUNCIATORS**  
 Drawing #8..... **CONTROL PANEL APPLICATIONS 1**  
 Drawing #9..... **CONTROL PANEL APPLICATIONS 2**  
 Drawing #10..... **CONTROL PANEL APPLICATIONS 3**  
 Drawing #11..... **PANEL PROGRAMMING**  
 Drawing #12..... **PANEL OPERATION**  
 Drawing #13..... **DIALER OPERATIONS**



## Fire Alarm Control Panel

Two Zone, Three Expansion Space Panel, 120 VAC, Cat. # EST1-2Z3  
Two Zone, Three Expansion Space Panel, 220 VAC, Cat. # EST1-2Z3-220  
Two Zone, Six Expansion Space Panel, 120 VAC, Cat. # EST1-2Z6  
Two Zone, Six Expansion Space Panel, 220 VAC, Cat. # EST1-2Z6-220

---

---

### 1.0 DESCRIPTION

The EST1-2Z3 (-220) & EST1-2Z6 (-220) Fire Alarm Control Panels are protective signaling systems which feature modular construction and installer programmable microprocessor technology. The international versions of the panel, EST1-2Z3-220 & EST1-2Z6-220, require 220 to 240 VAC, 50/60 Hz. input voltage for proper operation.

- **Panel Supervisory Features** include: continuous internal testing; a CPU watchdog timer; and module placement supervision.
- **Operational Features** include: alarm, supervisory, and trouble resound; fire drill mode; one man test mode; lamp test; alarm silence inhibit; and automatic alarm silence.
- **Programmable Options** include: verified or non-verified alarm; waterflow with or without retard; and supervisory Initiating Device Circuits (IDCs). Verified circuits support dry contact alarm initiating devices when used with high impedance smoke detectors. Indicating Appliance Circuits (IACs) may be programmed as silenceable or non-silenceable with continuous, 120 Strokes per Minute (SPM), California, or temporal rates (Figure 3.3). The temporal rate meets the requirements of the national emergency evacuation signal. Alarm silence/reset inhibit, automatic alarm silence, and off-premise AC/brownout 6 hr. trouble delay timers are provided. Resettable power for 4-wire smoke detectors is provided.
- **Hardware Options** include an RCT-1 Relay/City-Tie Module with provisions for municipal box, reverse polarity and dry relay contact operation. The BPAC Class A Base Panel Converter is available to convert the IDC and IAC circuits on the Base panels to Class A (Style D) IDC and Class A (Style Z) IAC wiring. The IDCA Class A (Style D) IDC Converter is available to convert 2IDC Two Zone IDC Modules to Class A (Style D) wiring. The DL1' Dialer Module provides a supervised connection to a Central Monitoring Station via dial-up telephone lines. The ADMM Four Circuit Remote Annunciator Driver Master Module and the ADSM Four Circuit Remote Annunciator Driver Slave Module are available to supervise and drive remote annunciation panels. All circuits external to the panel are transient protected. All circuits except the AC power wiring, municipal box, and relay contacts are power limited. Panel option module capacity is indicated in Table 1.1. The panels have steel enclosures with a textured baked enamel finish. The enclosure has a Lexan™ viewing window, key lock, and is suitable for semi-flush or surface mounting. Room is provided in the enclosure for standby batteries. Conduit and nail knockouts, and keyhole style mounting holes help support quick installation. An optional battery enclosure, model BC-2(R), is available when 10 Amp-Hour batteries are required.

The panel is listed by ULI to standard UL 864 and ULC to standard ULC S527.



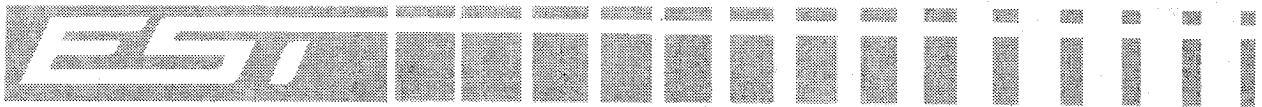

## 1.1 Components

### EST1-2Z3

**Two Zone, 120 VAC Base Panel w/3 Option Module Expansion Spaces, Cat.# EST1-2Z3(R)**

**Two Zone, 220 VAC Base Panel w/3 Option Module Expansion Spaces, Cat.# EST1-2Z3-220**

This panel provides two Class B (Style B) Initiating Device Circuits (IDCs) and two Class B (Style Y) Indicating Appliance Circuits (IACs). There is space for three option modules. Option modules include a Relay/City-Tie, Two Zone Initiating Device Modules, a Dialer Module, and Remote Annunciator Driver Modules. Space for standby batteries is provided in the enclosure. Refer to the Appendix to select the proper battery for your application.

### EST1-2Z6

**Two Zone, 120 VAC Base Panel w/6 Option Module Expansion Spaces, Cat.# EST1-2Z6(R)**

**Two Zone, 220 VAC Base Panel w/6 Option Module Expansion Spaces, Cat.# EST1-2Z6-220**

This panel provides two Class B (Style B) Initiating Device Circuits (IDCs) and two Class B (Style Y) Indicating Appliance Circuits (IACs). There is space for six option modules. Option modules include a Relay/City-Tie, Two Zone Initiating Device Modules, a Dialer Module, and Remote Annunciator Driver Modules. Space for standby batteries is provided in the enclosure. Refer to the Appendix to select the proper battery for your application.

**Table 1.1 - Base Panel Capacity**

Accessory/Option Module	Base Panel	
	EST1-2Z3 Panel Capacity: 3 Option Modules	EST1-2Z6 Panel Capacity: 6 Option Modules
Internal Batteries	2 each P/N 12V4A5, 12 V @ 4.5 AH 2 each P/N 12V6A5, 12 V @ 6.5 AH	2 each P/N 12V4A5, 12V @ 4.5 AH 2 each P/N 12V6A5, 12 V @ 6.5 AH 4 each P/N 6V8A, 6 V @ 8.0 AH
External Batteries	BC-2(R) Battery Cabinet 2 each P/N 12V10, 12 V @ 10 AH	BC-2(R) Battery Cabinet 2 each P/N 12V10, 12 V @ 10 AH
2 Zone Initiating Device Circuit 2IDC (P/N 240456)	Any Combination - 3 Max.	3 Max.
Relay/City-Tie Module RCT-1 (P/N 240511)		Any Combination - 3 Max.
Annunciator Driver Master Module ADMM (P/N 240460)		
Dialer Module DL1 (P/N 240508)		

### BPAC Base Panel Class A (Style D/Z) Converter Module (P/N 46199-1071)

This Class A (Style D/Z) Base Panel Converter changes the base panel to Class A (Style D) Initiating Device Circuits and Class A (Style Z) Indicating Appliance Circuits. The Class A Base Panel Converter does NOT require any option module expansion spaces.

### 2IDC Two Zone Initiating Device Circuit Module (P/N 240456)

This module provides two additional Class B (Style B) Initiating Device Circuits. Each circuit is provided with an ENABLE/DISABLE switch and a tri-color LED. The module requires one option module expansion space.

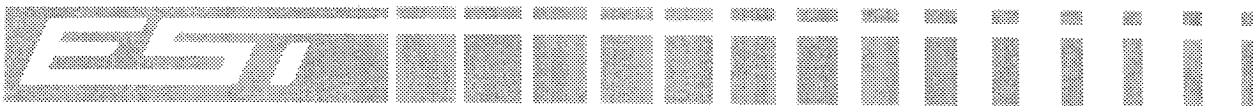

**IDCA Class A (Style D) IDC Converter Module (P/N 46199-1073)**

This Class A (Style D) IDC Converter changes the two Class B (Style B) Initiating Device Circuits on a Two Zone Initiating Device Circuit Module to Class A (Style D) operation. The module does NOT require any option module expansion space.

**RCT-1 Relay/City-Tie Module (P/N 240511)**

The Relay/City-Tie Module is a Normally-Open (N.O.) or Normally-Closed (N.C.) relay contact which is configurable to operate on panel Alarm, Trouble, Supervisory, or Reset conditions. The Relay/City-Tie Module may be configured for master box, reverse polarity, or dry contact operation. Relay contacts are rated for 24 VDC @ 1A operation. The module has a disconnect switch and an amber Trouble LED. The module requires one option module expansion space. Off premise power failure trouble signaling using this module has a 6 hour delay.

Table 1.2 - RCT-1 Battery Standby Requirements		
Feature	EST1-2Z3	EST1-2Z6
Dialer	Up to 60 Hrs.	Up to 60 Hrs.
Dry Contact (Shunt)	Up to 60 Hrs.	Up to 60 Hrs.
Master Box	Up to 60 Hrs.	Up to 60 Hrs.
Reverse Polarity	Up to 60 Hrs.	Up to 60 Hrs.

**NOTES:**

1. Refer to battery calculations.
2. NFPA 72 requires 60 hours of stand-by battery when connecting to an off premises monitoring location

Batteries are available in a variety of sizes to meet the 24 and 60 hour standby requirements, followed by 5 or 30 minutes in alarm. Table 1.1 shows the batteries suitable for each panel. Appendix 1 provides information on battery sizing.

**DL1 Dialer (Digital Alarm Communicator Transmitter) (P/N 240508)**

The DL1 dialer module is a Digital Alarm Communicator Transmitter (DACT) for transmitting alarm, supervisory and trouble information to a compatible Digital Alarm Communicator Receiver (DACR) via two dial-up telephone lines. The dialer supports 20 PPS 3/2 or 4/2 format for communicating between the panel and the DACR (see specifications). Both Dual Tone Multi Frequency (DTMF) and Pulse dialing are supported automatically. AC power failure reporting may be delayed. The dialer performs an automatic test call every 24 hours to verify communications between the fire alarm panel and the receiving equipment. Dialer module programming is performed with any standard tone dial(DTMF) telephone. All programming is password protected.

**ADMM Four Circuit Annunciator Driver Master Module (P/N 240460)**

The Four Circuit Remote Annunciator Driver Module is used to supervise and operate the connection to four individual alarm zone LEDs on a conventional zone annunciator. The ADMM is automatically configured for IDC zones 1 to 4. The Annunciator Driver Master Module requires one expansion module space in the enclosure.

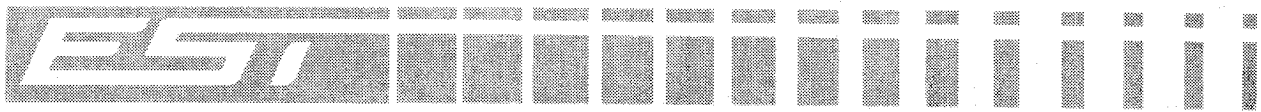

#### **ADSM Four Circuit Annunciator Driver Slave Module (P/N 240462)**

The Four Circuit Remote Annunciator Driver Slave Module is used to supervise and operate the connection to four additional alarm zone LEDs on a conventional zone annunciator. The ADSM is automatically configured for IDC zones 5 to 8. The Remote Annunciator Driver Slave Module mounts on the ADMM Master module, and does NOT require any expansion module space.

#### **RTU Remote Trouble Unit (P/N 46199-1075)**

The RTU Remote Trouble Unit is a remote trouble annunciator which displays fire alarm normal and trouble conditions. The unit is provided with a power LED and an integral trouble buzzer. A trouble silence switch with ring-back is also provided.

#### **xZA Remote Zone Annunciators**

The xZA Remote Zone Annunciators duplicate the control panel's individual zone alarm LEDs at a location remote from the control panel. Model 4ZA provides 4 zone LEDs, model 8ZA provides 8 zone LEDs.

#### **RTUxZA Combination Remote Annunciators**

The RTU-xZA Remote Annunciators combine the features of the RTU and the xZA annunciators in a single package. Model RTU4ZA provides remote trouble annunciation and 4 zone LEDs, model RTU8ZA provides remote trouble annunciation and 8 zone LEDs.

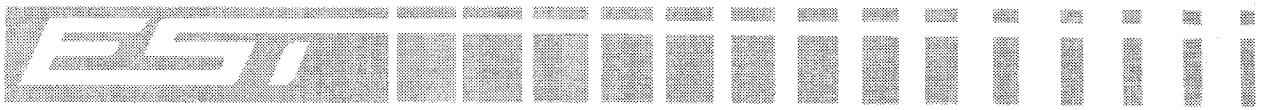

## 2.0 APPLICATION

EST1-2Z3 and EST1-2Z6 panels are suitable for small to medium size buildings, requiring from two to eight Initiating Device Circuits (IDCs), and two Indicating Appliance Circuits (IACs).

### 2.1 Fire Alarm System Limitations

Fire Alarm Systems provide the occupants of a facility with early warning of smoke and fire conditions. Fire alarm systems use a variety of components to meet the requirements of each installation. The fire alarm panel, automatic and manual detection devices, alarm annunciators, and the installation wiring are all factors in a reliable system. To maintain proper operation, fire codes require, and this manufacturer recommends preventive maintenance and testing on a routine basis by qualified personnel.

## 3.0 THEORY OF OPERATION

### 3.1 Initiating Device Circuits (IDCs)

The supervised IDCs operate with compatible smoke detectors (refer to Appendix) and normally-open alarm initiating devices. An IDC may be programmed as an Alarm, Waterflow/Supervisory, or Supervisory zone. Alarm zones may have verified or non-verified operation. Waterflow/Supervisory zones, programmed with or without a 15 second retard period, also support a *single* supervisory input device with a 1.1K $\Omega$  series resistor. IDC circuits may assume one of four operating states: Normal, Trouble, Alert, or Alarm. Table 3.1 defines the states for the various IDC zone types.

Table 3.1 - IDC Operation				
Zone Type	State of Operation			
	Alarm (Low Impedance)	Alert (High Impedance)	Normal (EOL $\Omega$ )	Open ( $\infty \Omega$ )
Non-Verified Alarm Zone	Alarm	Alarm	Normal Operation	Trouble
Verified Alarm Zone with high impedance smoke detectors and N.O. contact devices	Alarm	Verifying the Alarm	Normal Operation	Trouble
Verified Alarm Zone with smoke detectors only	Verifying the Alarm	Verifying the Alarm	Normal Operation	Trouble
Waterflow/Supervisory Zone	Alarm	Supervisory Condition	Normal Operation	Trouble
Waterflow/Supervisory Zone with Retard	Alarm after 15 seconds	Supervisory Condition	Normal Operation	Trouble
Supervisory Zone	Supervisory Condition	Supervisory Condition	Normal Operation	Trouble

**WARNING! Do NOT put contact devices on Low Impedance Verified Circuits.**

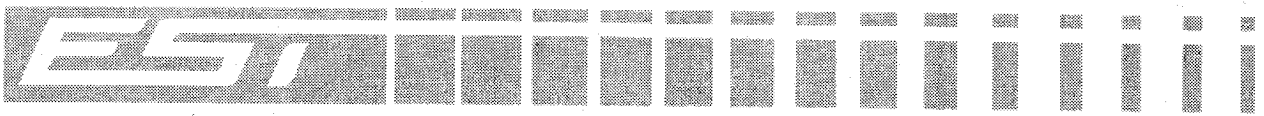

An active IDC defined as an Alarm or Waterflow Zone may be identified by a steady red zone LED. Active IDCs defined as supervisory zones may be identified by a rapid flashing amber zone LED.

When an IDC is programmed as a waterflow zone, the IACs DO NOT respond to the **ALARM SILENCE** switch or automatic alarm silence until the waterflow device is no longer active. Both an alarm initiating device and a *single* supervisory contact may co-exist on the same circuit by putting a 1.1K $\Omega$  in series with the supervisory contact. When the waterflow with retard option is programmed, a special algorithm samples the circuit repeatedly. If 66% of the samples taken in any 15 second period indicate a waterflow (shorted) condition, the circuit activates a waterflow alarm.

When an IDC is programmed as a verified zone and a smoke alarm is detected, the panel enters the Alarm Verification state. A 25 second sequence in which the detector is reset, delayed, and restarted is initiated, as shown in Figure 3.1. If auxiliary power is programmed as resettable, it is de-energized for the reset period. Following the reset-delay-restart sequence, a 60 second verification window is opened. If the verifying zone should go into the Alert, Alarm, or Trouble conditions within the 60 second window as shown in Figure 3.2, the panel enters the alarm mode. If any *other* IDC on the panel goes into the alert or alarm state during the verification period, the panel *immediately* enters the alarm mode. Dry contact alarm initiating devices may be combined with *high impedance* 2-wire smoke detectors on verified zones. The closing of a normally-open dry contact alarm initiating device generates an Alarm state immediately, and the panel enters the alarm mode.



#### NOTE

2-Wire Relay Bases are NOT supported on Initiating Device Circuits (IDCs).

#### Initiating Device Circuit, Class A (Style D) Operation

To convert a Class B (Style B) IDC zone to a Class A (Style D) IDC zone, install an BPAC Class A (Style D/Z) Converter on the *base panel*, or an IDCA Class A (Style D) Converter on the *Two Zone IDC Module*. The converters provides an alternate path to the zone module for all Initiating Devices in the event of a single wire break in an IDC.

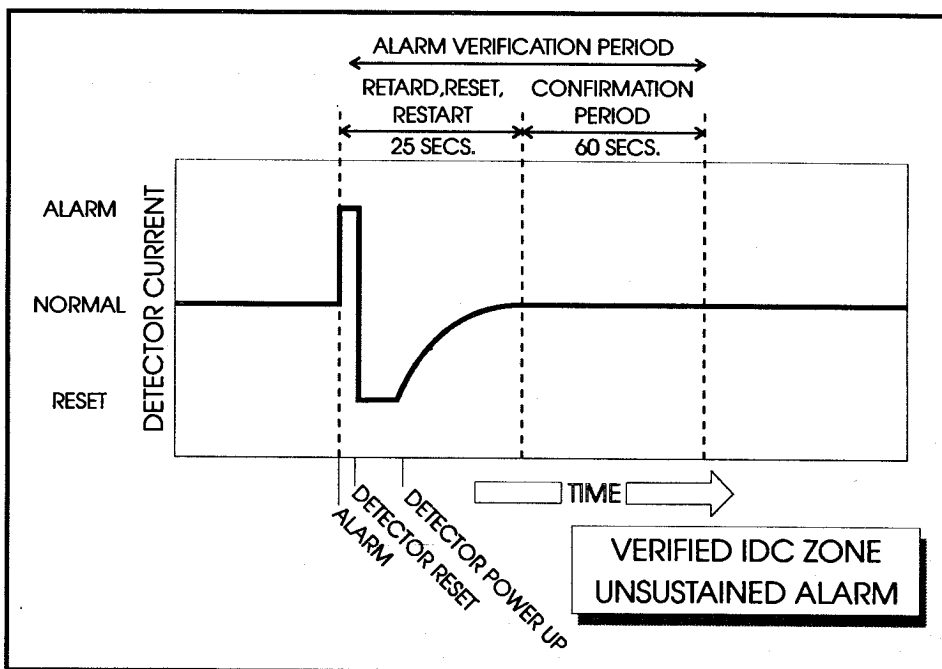

Figure 3.1 - Unsustained Alarm Operation

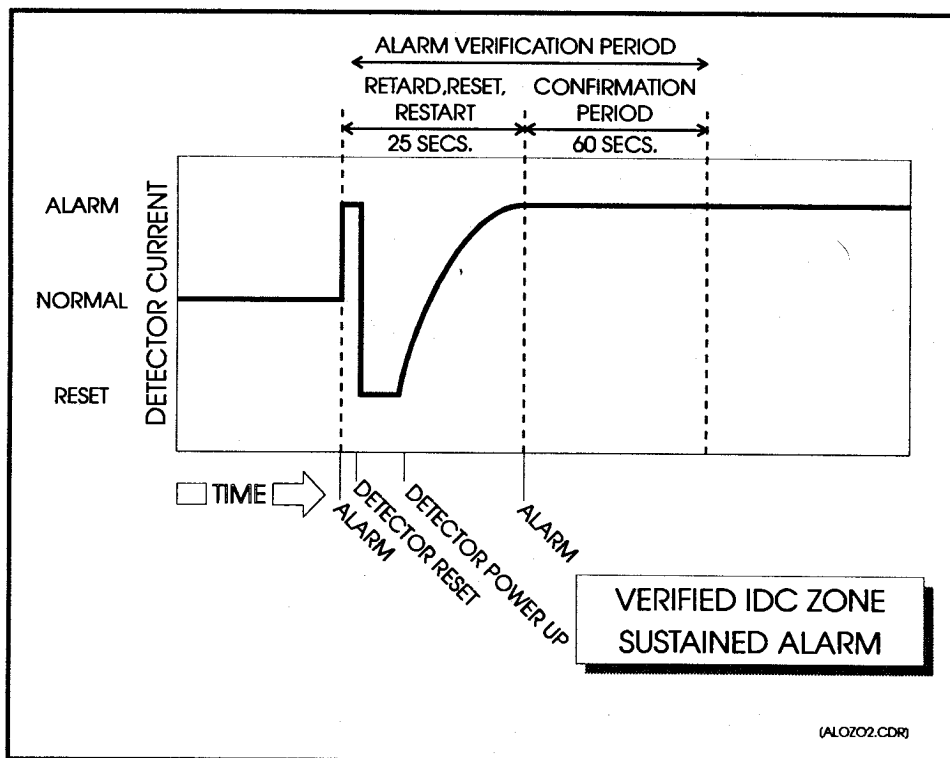
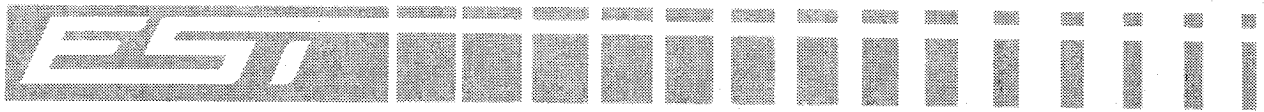

Figure 3.2 - Verified Alarm Operation



### 3.2 Indicating Appliance Circuits (IACs)

The supervised Indicating Appliance Circuits (IACs) operate using compatible 24 VDC (nominal) polarized signaling appliances. Each circuit is rated at nominal 24 VDC @ 2.5 Amps, with a total of 4.0 Amps available for both circuits. An IAC may be programmed as either silenceable or non-silenceable. Signal rate selection is independently programmable for each IAC, as shown in Figure 3.3. Refer to the Appendix for compatible Indicating Appliances.

IACs generate a trouble indication (slow flashing LED) when field wiring is *open* or *shorted*. In an open

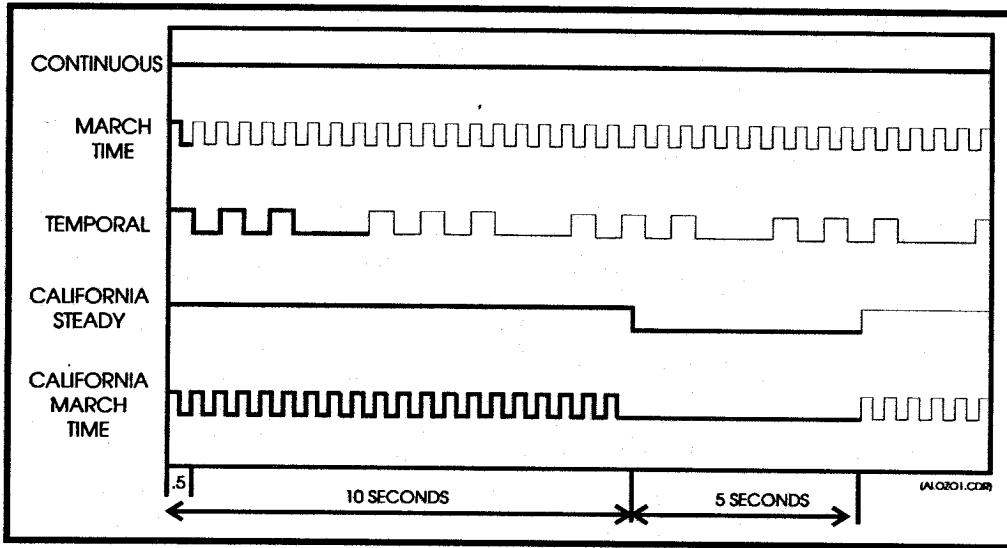
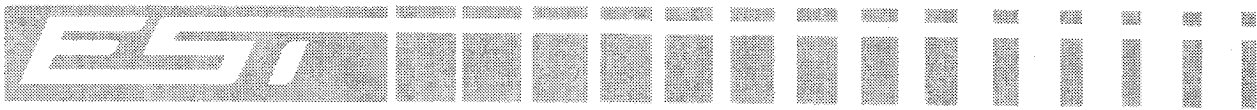

**Figure 3.3 - IAC Signal Rates**

fault condition, the panel will attempt to energize the signal appliances (i.e. all appliances up to the circuit break will operate). There is no assurance that any or all of the indicating appliances will operate. An IAC with shorted field wiring will NOT operate in the event of an alarm. If an IAC develops a short during an alarm, the IAC will automatically shut off and continuously monitor the field wiring. When the fault is cleared, the IAC will re-energize. These actions protect the power supply and other panel components from damage caused by the short circuit.

#### **Indicating Appliance Circuit, Class A (Style Z) Operation**

To convert Class B IAC zones to Class A (Style Z) IAC zones, install an BPAC Class A (Style D/Z) Converter Module on the base panel. The converter provides alternate paths to the base panel for both Indicating Appliance Circuits in the event of a single wire break in an IAC.



## 4.0 INSTALLATION

### 4.1 Codes and Standards

Install this panel in accordance with all applicable codes and standards to the satisfaction of the Authority Having Jurisdiction (AHJ). A partial list of codes and standards appears in the Appendix.

**US Installations:** For Class B (Style B/Y) circuits, the End-Of-Line resistor is installed on the last device.

**Canadian Installations:** For Class B (Style B/Y) circuits, purchase End-Of-Line resistor plates separately from your Distributor. Use the specified resistor and install in a separate electrical box in an accessible location beyond the last device on a circuit.

### 4.2 Site Storage

Remove the backbox from the top of the carton. Place extra modules in the panel carton and store the carton safely in a dry location during rough-in, to avoid damage to electronic parts.

### 4.3 Drawing References

Table 4.1 lists the drawings that are included at the end of this manual.

<b>Table 4.1 - Drawing References</b>	
<b>Subject</b>	<b>Drawing Title</b>
Assembly Details Ribbon Connectors Battery Interconnect	<b>CONTROL PANEL INSTALLATION 1</b> <b>CONTROL PANEL INSTALLATION 2</b>
Base Panel Circuits IAC Wiring Diagram IAC Wire Chart	<b>CONTROL PANEL</b>
Initiating Device Circuits IDC Wire Chart	<b>INITIATING DEVICE CIRCUIT WIRING</b>
2IDC Two Zone Initiating Device Circuit Module	<b>INITIATING DEVICE CIRCUIT WIRING</b> or see the Installation Sheet supplied with the Two Zone IDC Module
Relay/City-Tie Module Applications. Connections and Jumper Settings	<b>RELAY/CITY TIE MODULE</b> <b>CONTROL PANEL APPLICATIONS 1</b> or see the Installation Sheet supplied with the Relay/City-Tie Module
Dialer Installation & Programming	<b>DIALER MODULE</b>
Dialer Operations	<b>DIALER OPERATIONS</b>
Remote Annunciators & Annunciator Driver Modules	<b>REMOTE ANNUNCIATORS</b>
Battery Enclosure Installation 4-Wire Smoke Detectors	<b>CONTROL PANEL APPLICATIONS 2</b>
Class A Wiring	<b>CONTROL PANEL</b> <b>INITIATING DEVICE CIRCUIT WIRING</b> or see the Installation Sheets supplied with the BPAC Base Panel Class A Converter Module & IDCA, 2IDC Module Class A Converter
Panel Programming Instructions	<b>PANEL PROGRAMMING</b>
Panel Operations	<b>PANEL OPERATION</b>
Proprietary Station Wiring	<b>CONTROL PANEL APPLICATIONS 3</b>



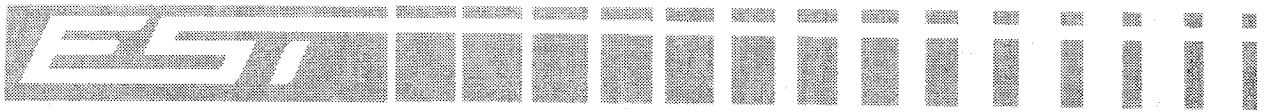

## 4.4 Installation Instructions

### Mounting the Backbox

Install backbox per drawings **CONTROL PANEL INSTALLATION 1** or **CONTROL PANEL INSTALLATION 2**. If a BC-2 Battery Cabinet is required, refer to the **CONTROL PANEL APPLICATIONS 2** drawing for information.

### Utility or Primary Power Circuit



#### NOTE

Install primary power conduit on *lower left side* or *left bottom* of backbox.

The panel requires a dedicated branch circuit. North American installations require 120 VAC, 15A, 50/60 Hz. power. International installations require 220-240 VAC, 15A, 50/60 Hz. power. Label the circuit breaker "Fire Alarm Control Panel." Within the fire alarm enclosure, route wire away from power limited circuit wiring.



#### WARNING

Do NOT apply power at this time.

### System Control Wiring

1. Refer to the drawings at the end of this manual for circuit wiring diagrams and wire charts showing maximum wire runs and loading. Install system wiring using the wire type and gauge per the Authority Having Jurisdiction. Locate field wiring conduit on the upper sides and top of the backbox. **At the panel, leave approximately 5' (1.5 m) of wire available for dressing and termination.** Pair and label wires according to zone and function. Do not mix power limited and non-power limited wiring in the same conduit.
2. Do NOT remove the factory installed EOL test resistors on the panel at this time. The test resistors are used for panel testing in the next steps. Refer to the drawings provided with each initiating and signaling device for installation details. Install End-Of-Line resistors at the end of Class B circuits.
3. Use an ohm meter to check circuit continuity and verify that the wiring is free of shorts and ground faults, as follows:

**Class B (Style B) IDC** meter readings should show 4.7K $\Omega$  (EOL Resistor) between circuit pairs. Each wire should show an *open* to ground.

**Class A (Style D) IDC** meter readings should show a *short* between each set of outgoing and incoming wires, and an *open* between each side of the circuit.

**Class B (Style Z) IAC** meter readings should show 4.7K $\Omega$  (EOL Resistor) between circuit pair in one direction and a short (polarized signals conducting) with the meter leads reversed. Each wire should show open to ground.

**Class A (Style Y) IAC** meter readings should show a *short* between each set of outgoing and incoming wires. Readings should show an *open* in one direction and a *short* (polarized signals conducting) with the meter leads reversed between each side of the circuit.

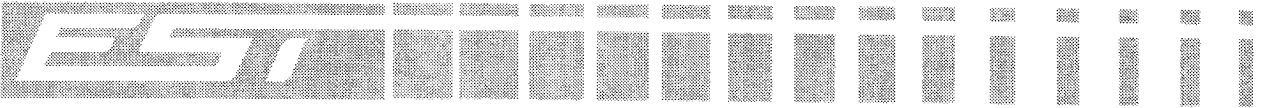

## Base Panel Assembly



### CAUTION

The electronic components used in this system are sensitive to static electricity. Always discharge any static buildup on your body by touching the panel enclosure before handling any electronic components.



### WARNING

The System Power Supply (the printed circuit board on the back of the Base Panel Assembly) handles up to 340 VDC when powered. **DO NOT** handle this board with power on.

1. Remove the Base Panel Assembly from its anti-static carton.
2. Remove and place the anti-static foam packing on a flat work area.
3. Place the Base Panel Assembly Display face down on the foam packing. *Leave the factory end-of-line resistors in place on the base panel and expansion modules until making final connections.*

### Option Module Installation

If your system requires no optional expansion modules, skip to the section entitled **Base Panel Assembly Installation**.

1. Refer to the **CONTROL PANEL INSTALLATION 1** and **CONTROL PANEL INSTALLATION 2** drawings.
2. Remove the Power Supply from the Base Panel Assembly to allow for first module installation.
3. Install Expansion Modules on the Base Panel Assembly from left to right (front view) starting with IDC Modules, Remote Annunciator Driver Modules, then the Relay/City-Tie Module. **Before installing the ADMM & ADSM Annunciator Driver Modules, verify that all jumpers are installed. Before installing the RCT-1 Relay/City-Tie Modules, verify that jumpers 1 & 2 are installed. Refer to RELAY/CITY-TIE & REMOTE ANNUNCIATOR drawings for additional jumper information.**



### NOTE

Dialer Module (DL1) **MUST** be installed in position number 3 or higher to prevent mechanical interference with other system components

**Do NOT** connect the Dialer Module's ribbon cable to the adjacent module until the rest of the system has been installed and tested.

4. Insert all ribbon connectors (except the dialer Module) into the adjacent socket, and re-install the Power Supply on the back of the Base Panel Assembly. The Dialer Module will be connected later.
5. For Class A (Style D/Z) circuits, install the BPAC Class A Converter modules on the back of the Base Panel Board and IDCA on the back of the IDC Expansion Modules. Refer to **CONTROL PANEL INSTALLATION 1**, **CONTROL PANEL INSTALLATION 2**, and **INITIATING DEVICE CIRCUIT** drawings.

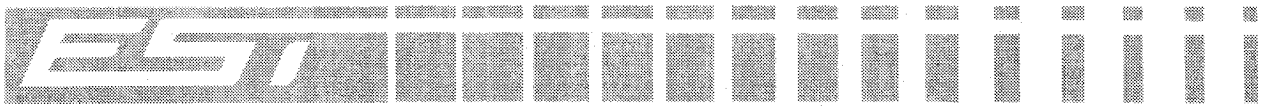

### Base Panel Assembly Installation

1. Refer to the **CONTROL PANEL INSTALLATION 1** or **CONTROL PANEL INSTALLATION 2** drawings. If a BC-2 Battery Cabinet is required, refer to the **CONTROL PANEL APPLICATIONS 2** drawing for information.
2. Lift wiring up and away from the backbox, and install the Base Panel Assembly using the four quick fasteners. **Do not connect control circuit wiring at this time.**
3. Install the panel door and make the ground connection (green wire) from the power supply to the middle door mounting stud.



### WARNING

Batteries can deliver extremely high currents. To prevent serious burns caused by short circuiting the battery, remove all jewelry before handling.

4. Place the batteries in the lower right area of the backbox. If using the external battery cabinet, locate the batteries in the battery cabinet.
5. Interconnect the cells per the **CONTROL PANEL INSTALLATION 1** or **CONTROL PANEL INSTALLATION 2** drawings. If a battery cabinet is being used, refer to the **CONTROL PANEL APPLICATIONS 2** drawing for connection information.

### Connect panel battery leads at this time.

Observe Polarity: Red = Positive (+); Black = Negative (-).



### CAUTION

Observe polarity. Red is positive(+), Black is negative(-). A non-replaceable fuse protects the system from damage caused by a reversed battery connection.

### Power Up

1. Verify that all factory installed end-of-line resistors are still in place, all ADMM & ADSM module jumpers are all installed, and RCT-1 module jumpers 1 & 2 are installed.
2. Connect primary power wires: Line, Neutral, and Ground to the input terminals of the power supply.
3. Energize AC power to the system. *When you first apply power to the system it will follow an initialization procedure. This procedure programs all connected IDCs as non-verified alarm inputs and identifies the configuration of all output modules (it can take up to 15 seconds). You will see zone LEDs turning on and off in sequence and communication LEDs (lower edge of expansion module boards) flashing. Allow the system to complete this procedure before touching any controls. At the end of the process, all LEDs except the Power On LED should be off. If the system trouble LED is on and the trouble signal is sounding, refer to the troubleshooting procedures in this manual. If module LEDs remain on steady, refer to the Programming section for additional information.*
4. Install the lower protective plastic barrier over the high voltage terminals. **Make sure to install this cover strip. It protects you from the high voltage input terminals and traces on the power supply printed circuit board.**

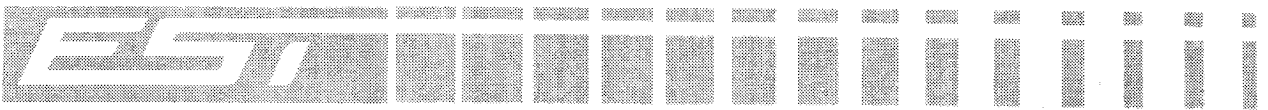

### Programming the Panel

1. Remove the Common Control insert card, reverse it, and then return it to its panel location. The Common Control switches are now labeled for programming functions.
2. Refer to Table 5.1 for panel default operations and the **PANEL PROGRAMMING** drawing for programming information. For Dialer Module programming refer to the **DIALER MODULE** drawing.
3. Fill-in the Panel Configuration & Programming Worksheets (located in the Appendix) and program the panel for the desired operation. *Save the Panel Configuration Worksheets for future reference.*
4. Remove, label, and re-insert the IDC, Relay/City-Tie, and Annunciator Driver Module insert cards. Use the Panel Configuration Worksheets in this manual to assist in labeling. Reverse the Base Panel insert card to display Fire Alarm Control functions.

### Panel Function Testing

1. Test panel operations by *shorting* (Alarm) or *opening* (Trouble) the factory installed End-Of-Line resistors.
2. To activate IDC circuits which combine *high impedance* smoke detectors and contact devices, or supervisory signal operation of a waterflow/supervisory circuit, use a 1.2K $\Omega$  resistor in parallel with the End-Of-Line resistor.
3. Remove the End-Of-Line resistor to verify proper trouble response.
4. Reset the panel, allowing 20 seconds for the panel to return to normal.

### IDC & IAC Field Wiring Connections

1. Refer to the **CONTROL PANEL INSTALLATION, INITIATING DEVICE CIRCUIT WIRING, CONTROL PANEL APPLICATIONS 1, & CONTROL PANEL APPLICATIONS 2** drawings for wiring details.
2. Dress all wires to allow "hinging" the Base Panel Assembly on the left by dressing your connections from right to left. This allows you to rotate the Base Panel Assembly out of the enclosure for access to system modules, facilitating additions or changes.
3. Leaving the system powered up, install the IDC & IAC circuits one at a time. The system will go into Trouble mode. Remember to **remove** the factory installed End-of-Line resistor from the panel or module terminals.)
4. Use the **TROUBLE SILENCE** switch to silence the Trouble signal.
5. Connect the appropriate field wiring, observing circuit polarity. If the wiring is correct, the trouble condition will clear (Trouble LED and amber Zone LED turn off).

### DL1 Dialer Panel and Field Wiring Connections

*To eliminate excessive calls to the Central Monitoring Station, the Dialer Module panel connection (ribbon cable) and programming should be performed after the balance of the panel has been tested and verified operational.*

1. Verify the Central Monitoring Station (CMS) is properly programmed and ready for connection.
2. Refer to the **DIALER** drawing and DACR technical manual for wiring and programming details.
- 3a. Dress all wiring to allow "hinging" the Base Panel Assembly on the right by dressing your connections from right to left. This allows you to rotate the Base Panel Assembly out of the enclosure for access to system modules, facilitating additions or changes.
- 3b. Fasten the dialer module to the panel assembly with the screws and standoffs provided.
- 3c. Fasten the bus interface adapter to the rear of the dialer, using the screws provided.
- 3d. Connect the ribbon cable to the next module in line. The system and dialer module will indicate trouble conditions.
- 4a. Set the panel's program switch to program mode (UP), and push the RESET switch.
- 4b. Wait for the Power LED to flash, then return the program switch to normal mode (down). This process installs the Dialer Module in the panel's data base. The panel will remain in trouble until the dialer is properly wired and programmed.

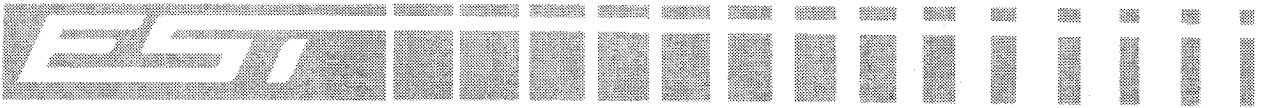

### CAUTION

The telephone jacks must be installed by an authorized representative of the telephone company. Phone lines must be loop start on the public switched network. PBX, ground start, and party lines are not acceptable.

5. Using the supplied 7Ft. (2.13 M) phone jack extension cables, connect J1 & J2 to the RJ31X, or RJ38X (CA31A or CA38A in Canada) telephone jacks. A protective grommet is supplied for the enclosure knockout. The telephone jacks must be installed by an authorized representative of the telephone company. The phone lines must be loop start on the public switched network. PBX and party lines are not acceptable.
6. With system powered up, program the dialer as shown in the drawing. **A new dialer module will remain disabled until completely programmed.** Use the TROUBLE SILENCE switch to silence the Trouble signal.
7. If the telephone lines are wired properly and the panel is programmed correctly, the trouble condition will clear (panel and module trouble LEDs turn off), when the dialer is enabled.
8. Activate and open all IDCs and IACs, verifying proper reception at the CMS.
9. Verify that failure of the primary signal path (phone line connected to J1) results in a trouble signal being transmitted via the secondary signal path (phone line connected to J2) within 4 minutes.
10. Verify that failure of the secondary signal path (phone line connected to J2) results in a trouble signal being transmitted via the primary signal path (phone line connected to J1) within 4 minutes.



### NOTE

If a DL1 Dialer Module is installed, it will introduce a panel trouble until programmed.



### NOTE

The DL1 Dialer Module will be disabled, with the LED "double flashing" amber until both phone numbers and both site ID numbers are set. Pressing the disconnect switch will have no effect.



### WARNING

The DL1 Dialer Module requires separate programming in order to operate. Refer to the **DIALER MODULE** Drawing.

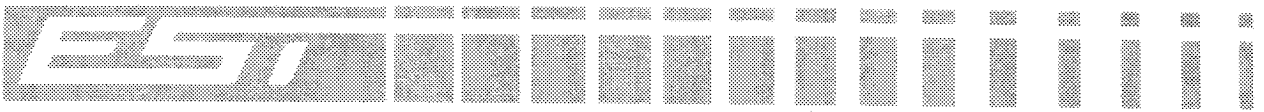

### **ADMM & ADSM Field Wiring Connections**

1. Refer to the **REMOTE ANUNCIATOR** drawing for wiring details.
2. Dress all wires to allow "hinging" the Base Panel Assembly on the left by dressing your connections from right to left. This allows you to rotate the Base Panel Assembly out of the enclosure for access to system modules, facilitating additions or changes.
3. Leaving the system powered up, connect the (+)24 VDC wire from the annunciator to the (+) Auxiliary Power terminal.
4. Connect the NO (Normally Open) and NC (Normally Closed) wires from the annunciator to the NO and NC trouble relay contacts on the control panel. Install a jumper between the trouble relay common terminal and the (-) Auxiliary Power terminal.
5. Install all supervision jumpers.
6. Connect the ADMM & ADSM LED circuits one at a time by removing the corresponding supervision jumper.
7. Use the **TROUBLE SILENCE** switch to silence the Trouble signal.
8. Connect the appropriate field LED wiring. If the wiring is correct, the trouble condition will clear (Trouble LED and amber Zone LED turn off).

### **RCT-1 Field Wiring Connections**

1. Refer to the **RELAY/ CITY-TIE** drawing and receiving station technical manual for wiring details.
2. Dress all wires to allow "hinging" the Base Panel Assembly on the left by dressing your connections from right to left. This allows you to rotate the Base Panel Assembly out of the enclosure for access to system modules, facilitating additions or changes.
3. Leaving the system powered up, remove jumpers 1 & 2, and install the required jumper configuration. The system will go into Trouble mode if the circuit is supervised.
4. Use the **TROUBLE SILENCE** switch to silence the Trouble signal, if sounding.
5. Connect the appropriate field wiring, observing circuit polarity. If the supervised wiring is correct, the trouble condition will clear (Trouble LED and amber Zone LED turn off).

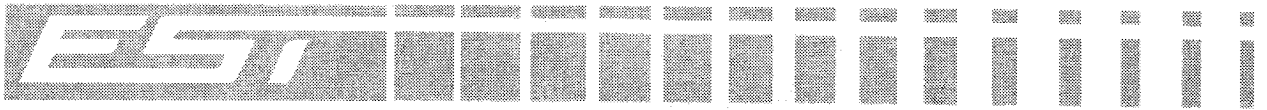

**Field Wiring Trouble (Also refer to Troubleshooting)**

1. Clear any wiring faults as you install the field wiring. When a fault on a Class B circuit is cleared, the panel will automatically return to the Normal mode. When a fault on a Class A circuit is cleared, the panel must be manually reset in order to return it to the Normal mode.
2. If an IAC is *shorted* (or a signal appliance connection is reversed) or *open*, the circuit will continue to display trouble. If an IAC has a *ground fault*, the trouble signal will resound and the Ground Fault LED will turn on.  
If an IDC has a *short*, the zone LED will change to red and the system will go into Alarm mode (delayed 25 seconds if the circuit is programmed as a Low Impedance verified smoke detector circuit). If an IDC has a *ground fault*, the trouble signal will resound and the Ground Fault LED will turn on.
3. Continue to complete supervised circuit connections one at a time using the panel to verify proper wiring.
4. Connect ancillary circuits, remote monitoring, and remote annunciation circuits per installation drawings in this manual.
5. Test each circuit for proper function by putting the system into Alarm, Supervisory, or Trouble modes. Refer to **Operating the Panel** for a description of testing procedures.

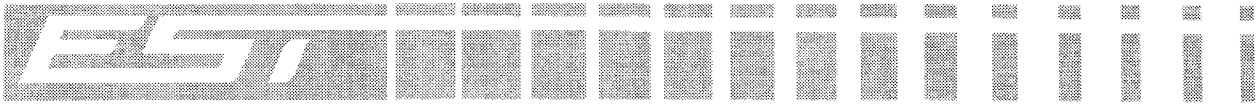

## 5.0 PROGRAMMING

Panel Configuration Worksheets may be found at the end of this manual. These worksheets should be filled out prior to programming the panel, and saved with this manual should further programming be required at a later date. Refer to the **PANEL PROGRAMMING** drawing during the programming process. The reverse side of the base panel identification labels are programming templates. Remove, reverse, and re-insert the template labels as a programming aid. Dialer programming is covered in section 5.6



### CAUTION

The panel **MUST** be reprogrammed whenever permanently *adding* (or *removing*) option modules to (from) the system. Replacing a module with another module of the same type does **NOT** require reprogramming.

The panel is shipped from the factory with the default configuration denoted by ✧ in Table 5.1. The panel defaults may be reprogrammed any time during the programming sequence by simultaneously pressing the **TROUBLE SILENCE** and **RESET** switches for one second, which also returns you to the start of the programming process. The programming step (of the panel being programmed) is indicated by the flash phase of the green Power LED. The program variable and flash phase is indicated in Table 5.2.

<b>Table 5.1 - Programmable Features</b> ✧ = Default	
<b>Initiating Device Circuit (IDC)</b>	
1 ✧	Non-Verified Alarm
2	Verified High Impedance Detector w/Contact Device (See Note)
3	Verified Low Impedance Detector Only
4	Supervisory
5	Waterflow & Supervisory
6	Waterflow w/retard & Supervisory
<b>Indicating Appliance Circuit (IAC)</b>	
1 ✧	Affected by alarm silence Features
2	Not affected by Alarm Silence Features
<b>IAC Signal Rates</b>	
1 ✧	Continuous
2	March Time @ 120 SPM
3	Temporal 3-3-3
4	Continuous ON for 10 Seconds., 5 Seconds. OFF
5	March Time ON for 10 Seconds., 5 Seconds. OFF
<b>Alarm Silence Inhibit Timer</b>	
1 ✧	No Timer
2	One Minute Inhibit
3	Two Minute Inhibit
4	Three Minute Inhibit
<b>Automatic Signal Silence Timer</b>	
1 ✧	No Timer
2	10 Minutes to Silence
3	20 Minutes to Silence
4	30 Minutes to Silence
<b>Auxiliary Power Reset</b>	
1 ✧	Auxiliary Power NOT Reset
2	Auxiliary Power Reset

NOTE: Do Not use this option. High Impedance detectors are not presently available.



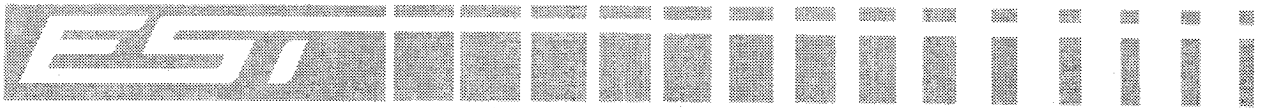

**Table 5.2 - Programming Step Indications**

Program Step	Power LED Flash Phase
Module Placement & Verification	1 = ☆ PAUSE ☆ PAUSE ☆...
Initiating Device Circuits (IDC)	2 = ** PAUSE ** PAUSE **...
Indicating Appliance Circuits (IAC)	3 = *** PAUSE *** PAUSE ***...
Timer Settings	4 = **** PAUSE **** PAUSE ****...
Auxiliary Power Setting	5 = ***** PAUSE ***** PAUSE *****...

To modify the panel default settings shown in Table 5.1, enter the programming mode as follows:

1. Move the **PROGRAMMING MODE** switch to the ON (up) position.
2. Press the **RESET** switch. The green Power LED will display a single-phase flash after approximately 20 seconds. The trouble buzzer sounds at a four pulse/minute rate, indicating you are in the automatic module placement and verification step of the programming process.

The panel automatically identifies all option modules installed in the panel by lighting each installed module's amber trouble LED. This process can take up to 30 seconds. Failure to light a module's trouble LED indicates a defective module or connection.



**NOTE**

If no front panel switches are activated for 15 minutes after entering the programming mode, the panel automatically exits the programming mode. The trouble buzzer will remain active as long as the **PROGRAMMING MODE** switch is in the ON (programming) position.

### 5.1 Programming Initiating Device Circuits (IDCs)

1. Press the **RESET** switch to enter the Initiating Device Circuit configuration step. The program IDC step is indicated by the 2-phase flashing green Power LED. IDC zones are programmed *individually*, starting with zone #1. The IDC zone actively being programmed is identified by an active *zone* LED. The IDC circuit type may be identified by the LED color and flash rate, using Table 5.3.

**Table 5.3 - IDC Zone Type Codes**

IDC Zone Type	Zone LED Code
Alarm, Non-Verified Detector	Steady Red
Alarm, Verified Detector & Dry Contact Alarm Initiating Devices (Do NOT Select this Option. High Impedance Detectors are not presently available.)	* PAUSE * PAUSE *... RED
Alarm, Verified Detector ONLY For Low Impedance Detectors only. No contact devices permitted.	** PAUSE ** PAUSE **... RED
Normally-Open Supervisory	Steady Amber
Waterflow	Steady Green
Waterflow with Retard	* PAUSE * PAUSE *... GREEN

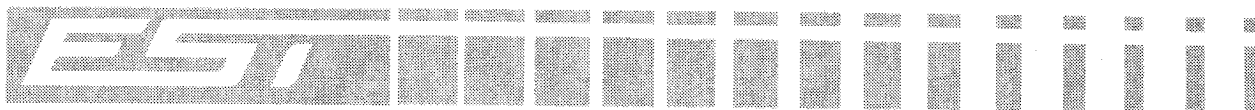

2. Use the **TROUBLE SILENCE** switch to step through the various IDC zone types, until the desired IDC type code is displayed by the LEDs.
3. Select the IAC circuit to be operated by this zone by pressing the **ALARM SILENCE** switch until the desired configuration is reached. Signal circuits selected for activation by the IDC are indicated by the respective IAC's Trouble LED illuminating.
4. To program the next Initiating Device Circuit, press the **RESET** switch and repeat steps 2 and 3 above.
5. When the last installed IDC has been programmed, press the **RESET** switch; the panel is now ready for programming Indicating Appliance Circuits (IACs).

## 5.2 Programming Indicating Appliance Circuits (IACs)

1. The panel is automatically ready to program Indicating Appliance Circuits. The program IAC step is indicated by the 3-phase flashing green Power LED. Each IAC zone is programmed *individually*, starting with IAC #1. The IAC circuit actively being programmed is identified by its active Signal Circuit trouble LED. The IAC circuit type may be identified by the status of the alarm silenced LED and by the flash pattern of the respective IAC trouble LED, as shown in tables 5.4 and 5.5.

Table 5.4 - Panel Indicating Appliance Circuit Status	
IAC Mode	Alarm Silenced LED
Silenceable	* PAUSE * PAUSE *...
Non-Silenceable	OFF

Table 5.5 - IAC Signal Output Rates	
IAC Circuit Type	Signal Circuit Trouble LED
Continuous	Steady
120 Strokes per Minute (SPM)	120 Flashes per Minute
Temporal (3-3-3)	FLASH-FLASH-FLASH-PAUSE
Continuous California Rate	10 Seconds ON, 5 Seconds OFF...
March Time California Rate	10 Seconds @ 120 SPM, 5 Seconds OFF...

2. Use the **ALARM SILENCE** switch to set IAC #1 as Silenceable or Non-Silenceable, as shown in Table 5.4 and indicated by the Alarm Silenced LED.
3. Use the **TROUBLE SILENCE** switch to step through the various IAC output signal rates, until the desired flash pattern is displayed for IAC #1.
4. Press the **RESET** switch to program IAC #2.
5. Use the **ALARM SILENCE** switch to set IAC #2 as Silenceable or Non-Silenceable, as shown in Table 5.4 and indicated by the Alarm Silenced LED.
6. Use the **TROUBLE SILENCE** switch to step through the various IAC output signal rates, until the desired flash pattern is displayed for IAC #2.
7. When IAC #2 has been programmed, press the **RESET** switch; the panel is now ready for Configuring the System Timers.

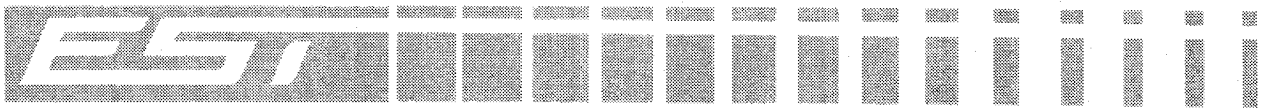

### 5.3 Configuring System Timers

1. The configure System Timers step is indicated by the 4-phase flashing green Power LED. The status of the panel's Alarm Silence Inhibit Timer is indicated by the *zone disabled* LED as shown in Table 5.6.

Table 5.6 - Alarm Silence Inhibit Timer Status	
Alarm Silence Inhibit Timer Setting	Zone Disabled LED
Disabled	OFF
1 Minute	* PAUSE * PAUSE *...
2 Minutes	** PAUSE ** PAUSE **...
3 Minutes	*** PAUSE *** PAUSE ***...

2. Use the TROUBLE SILENCE switch to select between the four states. The status of the panel's automatic Alarm Silence Timer is indicated by the *alarm silenced* LED as shown in Table 5.7.

Table 5.7 - Automatic Alarm Silence Timer Status	
Timer setting	Alarm Silenced LED
No timer	OFF
10 Minutes	* PAUSE * PAUSE *...
20 Minutes	** PAUSE ** PAUSE **...
30 Minutes	*** PAUSE *** PAUSE ***...

3. Use the ALARM SILENCE switch to toggle between the four states.
4. When the proper LED combination is displayed, press the RESET switch; the panel is now ready to program Auxiliary Power.

### 5.4 Programming Auxiliary Power

1. The program Auxiliary Power step is indicated by the 5-phase flashing green Power LED. Use the ALARM SILENCE switch to program the auxiliary power as shown in Table 5.8.

Table 5.8 - Auxillary Power on Reset Status	
Auxiliary Power	Alarm Silenced LED
Remains energized during reset	OFF
De-energize on reset (alarm, verification, & test modes)	* PAUSE * PAUSE *...

2. Use the ALARM SILENCE switch to toggle between the two states.
3. Press the RESET switch to return to the automatic module configuration step (1-phase flash), where the programming process started. You may modify any panel configuration by repeating the programming cycle.

**To exit the programming mode**, return the programming switch to the OFF (down) position. The panel should return to the Normal mode. You may exit the Programming mode at any time. This is useful when changing only one system parameter.

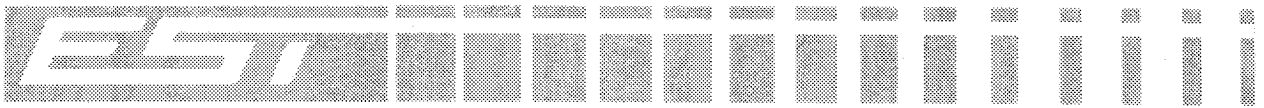

## 5.5 Returning to Panel Default Settings

To restore the panel to *system default settings*, before exiting the programming mode, press the **TROUBLE SILENCE** and **RESET** switches simultaneously for one second. This will return all parameters to default settings (Table 5.1), and return the panel to the beginning of the programming sequence.

## 5.6 Dialer Module Programming

Refer to the **DIALER MODULE** drawing

You will need to know the following information in order to program the dialer module:

- The primary and secondary telephone numbers at the CMS used to receive the signals.
- The DL1 Password = 4727 (GSBS).
- Site primary and secondary ID numbers for the dialer. The site ID numbers are supplied by the CMS.
- Number of retry attempts to CMS. Valid entries are 5 to 10.
- The retry interval. This is the delay time between subsequent attempts to call the CMS.
- The AC power fail notification delay time, if any.
- Daily dialer supervision message delay period. This is the delay interval from power until the first dialer supervision message is transmitted to the CMS. Valid entries are 0 to 18 hours, with a 12 Hour default time. The panel must be powered down, then powered up for a change in the delay time to take effect.
- Status retransmission enable/disable setting. Enable this option if the CMS requires all off-normal status to be re-transmitted with the daily dialer supervision message.

- A Put the dialer in the programming mode by plugging any tone dial telephone into J3 on the Dialer Module and lift the handset off-hook. *The touch pad dial on this phone is used for all dialer module programming.* If the Dialer Module is unresponsive, verify that steps 1 & 2 in the *DL1 Dialer Panel and Field Wiring Connections* section were performed.
- B Enter the dialer password using the programming phone. A beep indicates that a program item has been entered. NOTE: The dialer will make one attempt to call the monitoring station and report that it is disabled before you can proceed with programming.
- C When the LED goes solid green, you may select any programming item by entering an asterisk "\*" followed by the item number, e.g. "\*08" for AC fail delay. The suggested sequence is listed in the following steps:
- 1 Enter the primary site ID number supplied by the Central Monitoring Station (CMS).
  - 2 Enter the primary CMS phone number. **This is the primary phone number of the DACR receiving equipment, not the administrative phone numbers.**
  - 3 Enter the secondary site ID number supplied by the Central Monitoring Station (CMS).
  - 4 Enter the secondary CMS phone number. This is the secondary phone number of the DACR receiving equipment, not the administrative phone numbers.
  - 5 Select the number of phone lines to be used. NOTE: **Two lines are required to comply with NFPA 72.**
  - 6 Enter the number of times the module attempts to call the CMS receiving equipment.
  - 7 Enter the retry interval. This is the time between subsequent attempts to reach the CMS in the event of line trouble or busy signals.
  - 8 Enter the AC failure delay time. This is the length of the delay between the time AC power fails and the CMS is notified of the failure. NFPA requires a delay of 25% to 50% of rated standby power period. Valid entries are 0 to 18 hours. This setting does NOT effect any other trouble signals.
  - 9 Enter the daily supervisory message delay time. The module sends a supervisory message to the CMS once every 24 hours to verify the communications path and message receipt. The delay is used to set the time the daily message is transmitted based on a delay from the time the panel is powered up.
- EXAMPLE: If the CMS requires the daily supervisory message to be sent at 0300 (3 AM) and the current time is 1400 (2 PM), set the delay for 13 hours, power down, then power up.

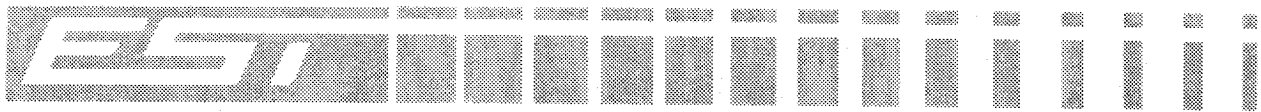

- 10 Enable or disable the status message re-transmission option. The dialer can optionally re-transmit all status messages when the daily dialer supervision message is sent. Status retransmission is in addition to the message sent when the event occurred.
  - 11 Select the order in which the zone number and status code are sent, zone first (default) or code first.
- D Hang up the handset and remove the programming telephone from Dialer Module jack J3 to end programming.

**NOTES:**

- 1 If no activity occurs in programming mode for one hour, the DL1 will exit from programming mode. To re-enter programming mode, hang up the programming phone, then start at step B of the programming procedure.
- 2 Factory new dialers remain disabled until both phone numbers and both site ID's are programmed. Once programmed, the dialer will attempt to call the monitoring station on power up. Programming mode cannot be entered until the call is completed, or all call attempts have failed.
- 3 When dialer programming step 10 is enabled, it causes all off-normal status, including alarms, to be retransmitted along with the 24 hour test call.

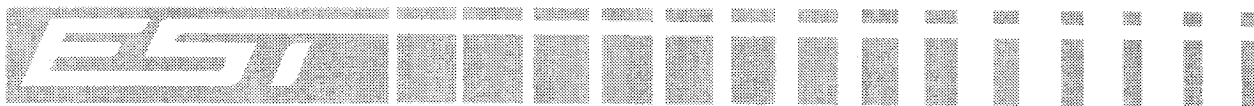

## 6.0 OPERATION

Table 6.1 - Panel Indicators	
Indicator	Function
Zone Disabled LED	** PAUSE ** PAUSE **... - One or more zones disabled *** PAUSE *** PAUSE ***... - Audible test mode **** PAUSE **** PAUSE ****... - Silent test mode
Power LED	ON - AC power normal OFF - AC power fail
Zone Alarm (Red) LED	STEADY - Zone in alarm
Zone Trouble (Amber) LED	STEADY - Supervisory condition restored RAPID FLASHING - Zone in supervisory alarm. SLOW FLASHING - Zone in trouble condition. ** PAUSE ** PAUSE **... - Zone disabled
Alarm Silenced LED	ON - The audible alarm signals have been silenced
Alarm LED	ON - System in the alarm state
System Trouble LED	SLOW FLASHING - System in Trouble state RAPID FLASHING - System in Supervisory state STEADY - Trouble buzzer silenced
Signal Trouble, Ckt #1 LED	SLOW FLASHING - Open/short on IAC #1 wiring
Signal Trouble, Ckt #2 LED	SLOW FLASHING - Open/short on IAC #2 wiring
Ground Fault LED	SLOW FLASHING - A ground fault condition exists on the panel or field wiring

### Normal Mode

In the Normal Mode, the panel is operating properly and has *not* detected any Alarm, Supervisory, or Trouble conditions. The green power LED is ON and all other LEDs are OFF in the normal mode.

### Alarm Mode

When a fire alarm condition is detected, the common alarm LED is ON (RED), and the panel is in Alarm Mode. If the alarm occurs while in trouble or supervisory mode, the panel displays the system trouble LED steady ON, and silences the trouble buzzer. The trouble relay continues to indicate panel trouble. Zone Trouble and Supervisory LEDs not in conflict with the alarm LEDs remain ON.



**WARNING**

Do NOT silence fire signals until certain that a fire condition does not exist.

In the alarm mode, the Indicating Appliance Circuits operate as programmed. The system alarm LED turns on, the alarm relay operates, and the Relay/City-Tie Module transmits a fire alarm condition, if so configured. The red IDC zone LED lights, indicating the area of the alarm. The appropriate alarm zone LED on the Remote Annunciator operates via the Annunciator Driver Module. The dialer will transmit a zone specific alarm signal to the Central Monitoring Station.

To silence the Indicating Appliances, press the **ALARM SILENCE** switch. Indicating Appliance Circuits will not respond to the **ALARM SILENCE** switch until all waterflow zones are no longer in the active alarm condition. Reactivation of the waterflow zone will reactivate the IACs.

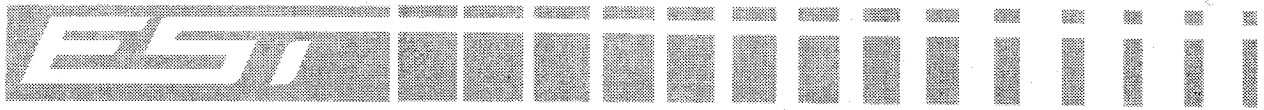

### **Reset Mode**

When the facility is safe to re-enter, the panel may be Reset. Manual stations and other manually restorable devices must be returned to their normal condition. Non-restorable devices which have been activated by the fire must be replaced. In the event replacement is not immediately feasible, disable the affected zone using its disable switch. Pressing the **RESET** switch automatically resets the smoke detectors and returns the panel to the normal (trouble mode if zones have been disabled) mode. If all alarm initiating devices have not been restored, the panel will re-enter the alarm mode. The entire reset process takes about 20 seconds to complete. The panel can **NOT** be reset while the alarm silence inhibit timer is active. Panel reset does not change a zone's enabled/disabled status.

Reset the panel by pressing the **RESET** switch. Reset causes the system trouble LED to light, the trouble buzzer to sound, and the trouble relay to go into the trouble state. Operation of the **RESET** switch also causes all front panel LEDs to turn on, verifying their operation. After internal processing is completed, the panel returns to the normal mode.

### **Trouble Mode**

When the panel is in the Trouble Mode, some portion of the panel or field wiring is in an abnormal condition and the proper operation of the fire alarm system may be affected. If an alarm is detected while in the trouble mode, the panel will enter the alarm mode and sound an alarm. If a supervisory condition is detected while in the trouble mode, the panel will enter the supervisory mode and the trouble contacts will remain activated.

In the trouble mode: the system trouble LED flashes, the trouble buzzer sounds at a rate of 20 pulses/minute, the trouble relay operates, and the Relay/City-Tie Module transmits a trouble signal if it is configured to transmit trouble. The dialer will transmit a trouble signal to the Central Monitoring Station. If the trouble occurs on an Initiating Device Circuit, the trouble message will be zone specific.

The Relay/City-Tie Module (if configured to transmit trouble) delays its trouble output for 6 hours when activated by a loss of AC power. The base panel trouble relay activates 6 seconds after the loss of AC power. The relay's 6 second contact transfer delay minimizes nuisance troubles due to brownouts and power line failures. All other trouble conditions are transmitted off premise without delay. In addition to the system trouble LED, IDC zones, IAC zones, and option modules light a unique trouble LED, further identifying the cause of the problem.

To silence the trouble buzzer, press the **TROUBLE SILENCE** switch. The system trouble LED will light steadily. New trouble conditions resound the trouble buzzer, and cause the system trouble LED to flash slowly. Correction of the problem causing a trouble condition automatically returns the panel to the normal mode, if no other faults exist. Certain critical internal faults and Class A trouble conditions latch the panel into the trouble mode, requiring the panel to be reset before exiting the trouble mode. Module placement trouble conditions remain active until the panel is reprogrammed.

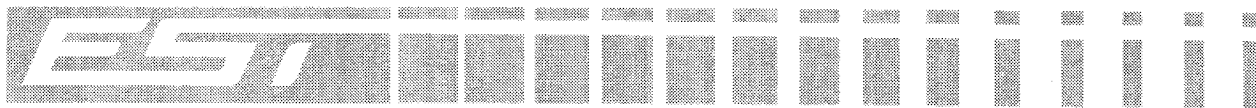

### Supervisory Mode

When the panel is in the Supervisory Mode, a portion of the building fire protection system (not the panel) is in an abnormal condition and its proper operation is affected. If an alarm occurs while in the supervisory mode, the panel will enter the alarm mode and sound an alarm. If a supervisory condition is detected while in the trouble mode, the panel enters the supervisory mode.

In the supervisory mode, the system trouble LED, amber supervisory zone LED, and trouble buzzer all operate at 120 pulses per minute. The trouble relay operates and the Relay/City-Tie Module (if configured to transmit supervisory alarm) transmits a supervisory and trouble signal. The respective zone LED on the remote annunciator will illuminate. The dialer will transmit a zone specific supervisory signal to the Central Monitoring Station.

Restoration of the supervisory condition causes the amber supervisory zone LED to light steadily. The trouble buzzer continues to pulse rapidly, or will resound if previously silenced. The respective zone LED on the remote annunciator will remain illuminated during the supervisory restore mode.

Press the **RESET** switch to exit the supervisory mode when all supervisory alarms have restored. The dialer will transmit a zone specific restore signal to the Central Monitoring Station.

### Drill Mode

The drill mode operates both IACs. The panel *will* leave the drill mode, enter the alarm mode, and sound an alarm if an alarm is detected. The panel *will* leave the drill mode and enter the supervisory mode if a supervisory condition occurs.

The drill mode is entered from the normal mode by *simultaneously* pressing the **ALARM SILENCE** and **RESET** switches for at least one second. Entering the drill mode places the panel in the trouble mode. The trouble LED will flash slowly. Pressing the **ALARM SILENCE** switch terminates the drill. The alarm relay and the Relay/City-Tie Module (when configured to transmit alarms) do not operate in the drill mode.

To exit the drill mode, *either* press the **ALARM SILENCE** switch, or press the **RESET** switch.

### IDC Zone Disable

Initiating Device Circuits (IDCs) may be individually Disabled by operating a zone's **ZONE DISABLE** switch.



### WARNING

Disabling a zone removes the zone's ability to put the panel in an Alarm or Supervisory condition.

Disabling a zone permits the panel to be reset and restore protection to all zones except the disabled ones. The **ZONE DISABLE** switch is also used to select a zone for testing, as detailed in the section entitled **Test Mode**.

When a zone(s) is disabled, the Zone Disabled LED as well as the individual zone trouble LED exhibit a 2-phase flash, and the panel is put in the trouble mode. If the panel was in an Alarm, Supervisory, or Trouble state when the **ZONE DISABLE** switch was activated, the panel will *not* return to normal.

When a disabled zone is re-enabled, its zone LED indicates its status. If a re-enabled zone indicates it is in alarm, the panel will wait 10 seconds before going into the alarm mode. Pressing the **ZONE DISABLE** switch within the 10 second period disables the zone again, without the panel going into the alarm mode. A disabled zone's status is retained in the panel's memory during power down, and will remain disabled upon power up. Panel reset does not change a zone's enabled/disabled status.



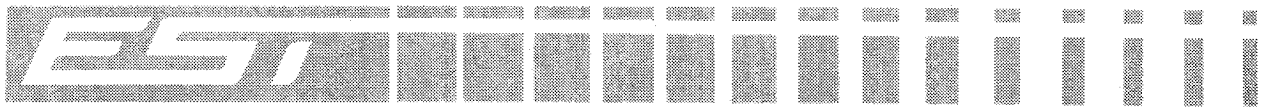

### Test Mode

The Test Mode is used to verify the operation of the panel, alarm initiating devices, and the integrity of field wiring.



### WARNING

Fire detection capability on the zone(s) under test is NOT functional in the Test Mode.

The panel *will* leave the test mode, enter the alarm mode, and sound an alarm if a zone *not* selected for testing detects an alarm. The panel *will* leave the test mode and enter the supervisory mode if a zone *not* selected for testing detects a supervisory condition. Putting the panel in the test mode also puts it in the trouble mode.

Select an IDC zone(s) for testing by operating its respective zone disable switch(s). The "audible" test mode is entered from the normal or trouble modes by *simultaneously* pressing the **TROUBLE SILENCE** and **RESET** switches for at least one second. This causes the zone disabled LED to show a 3-phase flash and the trouble buzzer to pulse slowly. The trouble buzzer can be silenced in the test mode. The alarm relay, Relay/City-Tie Module (when configured to transmit alarms) will *not* operate in the test mode unless a valid alarm on any zone not being tested is received. Pressing the **TROUBLE SILENCE** and **RESET** switches a *second time*, for at least one second while in the audible test mode, puts the panel in the "silent" test mode. This causes the zone disabled LED to show a 4-phase flash and the trouble buzzer continues to sound. The silent test mode operates identically to the audible test mode with the exception that the IACs are not activated. The use of a Preventive Maintenance Tester (P/N 46288-0017) is recommended when performing a *silent* walk test.

Any alarm (verified or non-verified) on a zone under test will operate both IACs. The panel will sound one *short* pulse for zone 1, five *short* pulses for zone 5, etc., audibly identifying the number of the zone successfully tested. A trouble condition or ground fault on any zone under test, or an *open* or *ground* on either IAC, sounds a one second pulse on both IACs. If the auxiliary power is programmed as resettable, it will be deactivated while the zone under test is being reset.

In the test mode, the time the disabled IDC zone(s) takes to reset is characteristic of the source initiating the test sequence, as shown in Table 6.2. This feature is primarily used when testing in the *silent* test mode. The IDC zone reset period may be determined by measuring the length of time that the nominal IDC voltage (24 VDC) equals 0 VDC.

**Table 6.2 - Test Mode**

Initiating Condition	IAC Response (Audible Test Mode Only)	IDC Zone Reset Period (Audible & Silent Test Modes)
Alarm on disabled IDC under test	Coded zone #	8 seconds
Open on disabled IDC under test	1 second pulse	4 seconds
Ground fault on any panel wiring	1 second pulse	2 seconds
Open IAC circuit	1 second pulse	Not Applicable

 **NOTE**

When verifying the operation of strobe lights using the Test Mode, the strobe lights may not receive enough energy to successfully charge. Use independent test methods such as Drill Mode to verify strobe lights and field wiring.

 **NOTE**

Before exiting Test Mode, be sure to Enable the zone(s) that were Disabled for testing.

 **CAUTION**

If there is no activity on the system for 30 minutes, the system will exit the Test Mode and the Disabled zone(s) will remain Disabled.

To exit the test mode, press and hold the **RESET** switch for one second.

**Dialer Operations**

Refer to **DIALER OPERATIONS** drawing

**Table 6.3 - Dialer LED Indications**

Display	Description
Single Flash GREEN	Call to Central Monitoring Station in progress.
Steady RED	Alarm Sent & Acknowledged
Fast Flash AMBER	Supervisory alarm sent & Acknowledged
Steady AMBER	Supervisory restore sent & acknowledged.
Single Flash AMBER	Module in trouble
Double Flash AMBER	Module disabled

**Remote Trouble Unit**

The green Power LED will be on whenever the RTU is receiving power from the control panel.

The Amber Trouble LED will be on whenever the control panel is in trouble.

The Trouble Buzzer will sound when the control panel is in trouble and the trouble silence switch is in the normal position, **and** will sound when the control panel is not in trouble and the trouble silence switch is in the silence position.

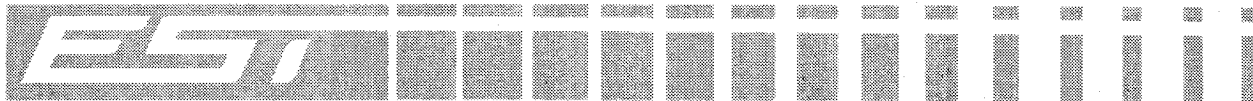

## 7.0 TROUBLESHOOTING



### CAUTION

Disconnect AC and battery power before installing or removing modules.



### WARNING

Lethal voltages from other equipment may be present within the panel even with the alarm system AC power source disconnected.

**Table 7.1 - Trouble LEDs**

Condition	Possible Cause
3 or 4-Phase flashing Amber ZONE DISABLED LED	1. System is in the Test mode (Disabled zones are under test)
Slow flashing Amber TROUBLE LED & Signal Appliances operating	1. System is in the Drill mode
Slow flashing Green POWER ON LED & Trouble Buzzer pulsing	1. System is in the Program mode 2. Program switch in "ON" position
Slow flashing Amber Common TROUBLE LED	1. Circuit open, missing or wrong EOL resistor 2. Fuse F1 open 3. Excessive load on auxiliary power terminals 4. Battery lead not connected or open 5. Battery fuse open 6. Defective batteries 7. Defective power supply 8. Battery lead poorly connected 9. Battery low and currently charging 10. New module installed on power/data bus 11. Unresponsive module on power/data bus 12. Programming Mode Switch in program mode
NOTE: When ONLY the common trouble LED is lit, the problem is related to possible causes 3 through 12. To determine the cause: 1. Silence the Trouble 2. Duplicate fault conditions 3 to 12, one at a time to see if there is a subsequent trouble. When NO subsequent trouble when the fault is duplicated, you have isolated the cause of the trouble.	
Slow flashing Amber TROUBLE LED, & slow flashing Amber Signal Trouble LED	1. Electronic circuit breakers open 2. Circuit open, missing, or incorrect EOL resistor 3. Circuit shorted, improperly installed device
Slow flashing Amber TROUBLE LED & Ground Fault LED.	1. Ground fault on field wiring
RCT-1 Trouble LED	1. Open Circuit on field wiring 2. Master box not reset
ADMM Trouble LED	1. Field wiring open

**Table 7.2 - Panel Trouble**

Condition	Possible Cause
4-Wire detectors will not reset	Auxiliary power not programmed as resettable
2-phase flashing Amber zone LED & zone disabled LED	Zone disable switch activated
3-phase flashing Amber zone LED & zone disabled LED	Zone in audible test mode
4-phase flashing Amber zone LED & zone disabled LED	Zone in silent test mode
Power LED flashing, panel will not work	Programming Mode Switch in the ON position

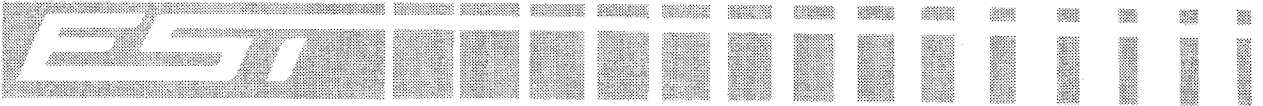

**Table 7.3 - Dialer Module LED Trouble Codes**

Condition	Possible Cause
Trouble (☆ PAUSE ☆ PAUSE ☆...AMBER)	1. Retry count exceeded, unable to communicate. 2. Phone line open or shorted.
Disabled (☆☆ PAUSE ☆☆ PAUSE ☆☆... AMBER)	1. Disable switch activated. (dialer will automatically re-enable in 24 Hrs. and transmit current status) 2. Dialer not completely programmed. 3. In programing mode, waiting entry of 24 hour test call offset time.

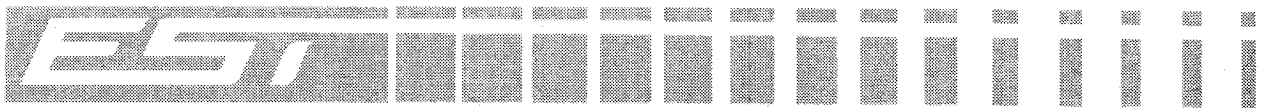

## 8.0 PREVENTIVE MAINTENANCE

Before commencing testing, notify all areas where the alarm sounds and off premise locations that receive alarm and trouble transmissions that testing is in progress.

- Records of all testing and maintenance shall be kept on the protected premises for a period of at least five (5) years.
- Required Tools:
  - Slotted Screwdriver, Insulated
  - Digital Multimeter.
  - 1.1K $\Omega$ , 1W resistor
  - 12" (30.5 cm) jumper lead with alligator clips
  - Panel Door Key
- A complete check of installed field wiring and devices should be made at regular intervals, in accordance with NFPA 72 and ULC 524 requirements. This includes testing all alarm and supervisory alarm initiating devices and circuits, and any off premise connections.
- Panel operation should be verified in the alarm, supervisory, and trouble modes.
- To ensure that the panel can be powered when primary power is lost, the batteries should be periodically inspected, tested, and replaced (as a minimum) every four (4) years.

## 8.1 Preventive Maintenance Schedule

Table 8.1 - Preventive Maintenance Schedule		
Component	Testing Interval	Test Procedure
Manual Stations	Semi-annually	<ol style="list-style-type: none"> <li>1. Visual inspection</li> <li>2. Put zone in test mode</li> <li>3. Activate mechanism</li> <li>4. Verify proper IDC zone response</li> </ol>
Non-Restorable Heat Detectors	Semi-annually	<ol style="list-style-type: none"> <li>1. Visual inspection</li> <li>2. Put zone in test mode</li> <li>3. Test mechanically and/or electrically</li> <li>4. Verify proper IDC zone response</li> </ol>
Restorable Heat Detectors	Semi-annually	<ol style="list-style-type: none"> <li>1. Visual Inspection</li> <li>2. Put zone in test mode</li> <li>3. Activate at least one detector on each IDC. Within five years all detectors on each IDC shall be tested</li> </ol>
Smoke Detectors	Annually	<ol style="list-style-type: none"> <li>1. Visual inspection</li> <li>2. Put zone in test mode</li> <li>3. Functional test to verify proper IDC zone response</li> <li>4. Check sensitivity</li> <li>5. Clean as required</li> </ol>
Waterflow Switches	2 Months	<ol style="list-style-type: none"> <li>1. Put zone in test mode</li> <li>2. Activate sprinkler test valve. Refer to Sprinkler system test procedure.</li> </ol>

Table 8.1 continued on next page.

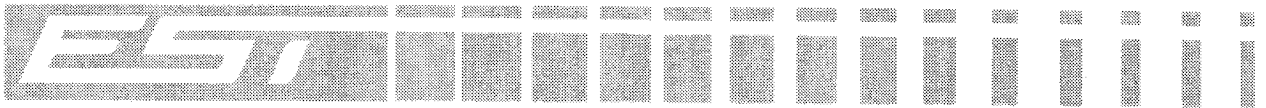

**Table 8.1 - Preventive Maintenance Schedule (Continued)**

<b>Component</b>	<b>Testing Interval</b>	<b>Test Procedure</b>
Supervisory Signal Initiating Devices	Semi-annually	<ol style="list-style-type: none"> <li>1. Put zone in test mode</li> <li>2. Operate valve</li> <li>3. Test pressure, temperature, and water level sensors per the sprinkler system test procedure</li> </ol>
Remote Annunciators	Annually	<ol style="list-style-type: none"> <li>1. Verify all indicators operating properly.</li> <li>2. Verify RTU Trouble Signal operating properly.</li> </ol>
Alarm Indicating Appliances	Annually	<ol style="list-style-type: none"> <li>1. Visual Inspection</li> <li>2. Put panel in alarm, drill, or test mode. Verify all indicating appliances operating properly</li> </ol>
All Initiating Device Circuits Verified Non-Verified Waterflow Waterflow w/ Retard Supervisory	Annually	<ol style="list-style-type: none"> <li>1. Bypass zone and enter test mode</li> <li>2. Short IDC zone (15 seconds for waterflow). IACs should activate, sounding the zone number</li> <li>3. Wait 15 seconds. Place 1.1K<math>\Omega</math> across IDC. IACs should activate, sounding the zone number</li> <li>4. Wait 15 seconds, then open the IDC field wiring. IACs should activate, sounding a 1 second pulse</li> <li>5. Wait 15 seconds, then ground one side of the IDC field wiring. IACs should activate, sounding a 1 second pulse</li> <li>6. Reset and lock panel at conclusion of all testing</li> </ol>
Panel LEDs & Trouble Buzzer	Annually	<ol style="list-style-type: none"> <li>1. Illuminate all LEDs by pressing the <b>RESET</b> switch</li> <li>2. Reset and lock panel at conclusion of all testing</li> </ol>
Panel Primary Power	Acceptance and Re-acceptance tests	<ol style="list-style-type: none"> <li>1. Remove Primary AC power</li> <li>2. Verify panel operates from battery</li> <li>3. Verify panel goes into trouble (6 second delay)</li> <li>4. Restore AC power at end of test</li> <li>5. Reset and lock panel at conclusion of all testing</li> </ol>
Panel Secondary Power	Acceptance and Re-acceptance tests	<ol style="list-style-type: none"> <li>1. Remove Primary AC power</li> <li>2. Measure standby and alarm currents, and compare with battery calculations to verify adequate battery capacity.</li> <li>3. Test under full load for five (5) minutes</li> <li>4. Measure battery voltage under full load (20.4 to 27.3 VDC)</li> <li>5. Restore AC power at end of test</li> <li>6. Reset and lock panel at conclusion of all testing</li> </ol>
Panel Trouble Signals	Annually	<ol style="list-style-type: none"> <li>1. Verify operation of system trouble LED and trouble buzzer</li> <li>2. Reset and lock panel at conclusion of all testing</li> </ol>
Auxiliary System Off-Premise Fire Alarm Signal Transmission	Monthly	<ol style="list-style-type: none"> <li>1. Coordinate test with receiving location</li> <li>2. Verify receipt of all transmitted signals</li> <li>3. Reset and lock panel at conclusion of all testing</li> </ol>
Remote System Off-Premise Waterflow Signal Transmission	Every 2 Months	<ol style="list-style-type: none"> <li>1. Coordinate test with receiving location</li> <li>2. Verify receipt of all transmitted signals</li> <li>3. Reset and lock panel at conclusion of all testing</li> </ol>

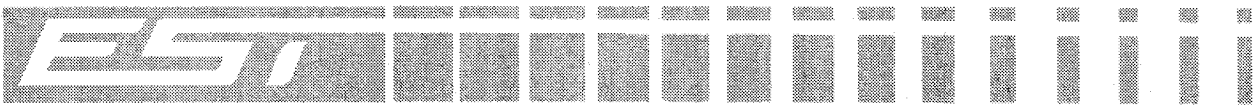

## 8.2 Testing Procedures for the DL1 Dialer Module

Every Six months (or as required by the Authority Having Jurisdiction):

- Verify that the dialer module is connected to two separate phone lines.
- Activate an alarm initiating device and verify the alarm is received at the Central Monitoring Station (CMS). Restore System to normal.
- Verify that failure of the primary signal path (phone line connected to J1) results in a trouble signal being transmitted via the secondary signal path (phone line connected to J2) within 4 minutes.
- Verify that failure of the secondary signal path (phone line connected to J2) results in a trouble signal being transmitted via the primary signal path (phone line connected to J1) within 4 minutes.

## 8.3 Testing Procedures for Compatible 2-Wire Smoke Detectors

### EST 6250

- **Functional Test:** Hold a magnet next to the alarm LED. The detector should alarm within 5 seconds.
- **Cleaning:** To clean the ion chamber, disable the zone using the **ENABLE/DISABLE** switch to prevent accidental alarm. Remove the detector from its base. Remove the grill. Place the vacuum cleaner nozzle over the chamber and remove dust. Reinsert the grill by aligning the tabs on the grill with the slots on the housing. Press the grill into the housing and turn clockwise until the grill locks into position.

### EST 6270

- **Functional test:** Insert the long end of the calibrated test probe (P/N 6278-001A) into the oblong opening on top of detector grill. The detector should alarm within 10 seconds. Insert the short end of the calibrated test probe into the oblong opening on top of the detector grill. The detector should NOT alarm within 10 seconds. If an alarm occurs, clean or replace the detector.
- **Cleaning:** To clean photo chamber, disable the zone using the **ENABLE/DISABLE** switch to prevent accidental alarm. Remove the detector from its base. Remove the grill. Vacuum dust and foreign material from the optic ramp area. Remove the bug screen from the grill. Wash the bug screen and grill in water and air dry. Reinsert the screen into the grill. Reinsert the grill by aligning the arrow on the rim of the grill with the LED on the housing and turn clockwise until the grill locks into position.



### CAUTION

If the grill is removed while the detector is in its base, the detector will generate an alarm.



### NOTE

Aerosol test sprays are NOT recommended due to possible interaction with composite detector housings.

At the conclusion of testing, notify all locations previously contacted that testing is complete.

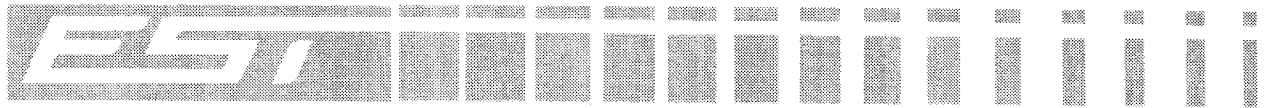

## 8.4 Replacement Parts

Table 8.2 - Related/Spare Parts	
Part ID	Description
12V6A5	12 V, 6.5 AH Battery (2 required)
6V8A	6 V, 8.0 AH Battery (4 required)
12V10A	12V, 10 AH Battery (2 required)
46288-0017	Preventive Maintenance Tester
46071-0409	ULI Listed series supervisory resistor (1.1K $\Omega$ ) and ULI Listed EOL resistor (3.6 K $\Omega$ )
EOL-P1	ULC Listed End-Of-Line Resistor on 1-Gang Plate
46229-0107	4.7K $\Omega$ UL Listed End-Of-Line Resistor
46097-0110	Battery Cabinet 8 Amp Fuse
46063-1055	EST1-2Z3 Gray Replacement Door
46063-1056	EST1-2Z3R Red Replacement Door
46063-1057	EST1-2Z3-220 Gray Replacement Door
46063-1058	EST1-2Z6 Gray Replacement Door
46063-1059	EST1-2Z6R Red Replacement Door
46063-1060	EST1-2Z6-220 Gray Replacement Door
46166-0144	Cat. # 45 Lock & 2 Keys
46262-0007	0.5" (13 mm) Hex threaded Standoff
46073-0138	EST1-2Z3 Terminal Cover (2 required per panel)
46073-0139	EST1-2Z6 Terminal Cover (2 required per panel)



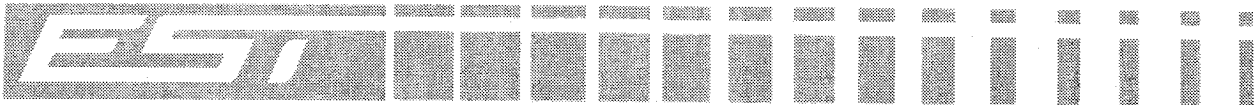

## 9.0 SPECIFICATIONS

<b>Table 9.1 - Specifications</b>	
<b>Base Panel Assemblies</b>	
Dimensions (HWD) EST1-2Z3 Panel Back box Finished EST1-2Z6 Panel Back box Finished	12" x 14" x 2.75" [30.5 cm x 35.6 cm x 7.0 cm] 14" x 15.75" x 1.125" [35.6 cm x 40.0 cm x 2.9 cm] 13" x 20.19" x 2.75" [33.0 cm x 51.3 cm x 7.0 cm] 15" x 22" x 1.125" [38.1 cm x 55.9 cm x 2.9 cm]
Weight (less battery) EST1-2Z3 Panel EST1-2Z6 Panel	12 lbs. (5.5 Kg) 16 lbs. (7.3 Kg)
Input Power EST1-2Z3 & EST1-2Z6 EST1-2Z3-220 & EST1-2Z6-220	120 VAC @ 3.5 A, 50 - 60 Hz 220-240 VAC @ 1.75A, 50 - 60 Hz.
Output Power - Signals	24 VDC @ 4A. Refer to Compatibility Section.
Auxiliary Power	24 VDC nominal @ 500 mA filtered, reset programmable. Refer to Compatibility Section.
Maximum Capacitance	100 $\mu$ F
Option Module Spaces	EST1-2Z3 Panel: 3 Input/Output EST1-2Z6 Panel: 3 Input and 3 Output
Battery Type EST1-2Z3 Panel  EST1-2Z6 Panel	2 x 12 V, 6.5 AH, Lead-Acid  2 x 12 V, 6.5 AH, Lead-Acid 4 x 6 V, 8.0 AH, Lead-Acid
BC-2(R) Battery Cabinet	2 x 12 V, 10AH, Lead-Acid
Ground Fault Detection	10K $\Omega$ to earth, all field wiring except AC input and common relay contacts.
IDC Zones Style Configurations	Two Class B (Style B) or Class A (Style D) Verified or non-verified alarm Waterflow or waterflow with retard Supervisory
Detector Capacity per IDC Circuit	30 - photoelectric smoke 50 - ionization smoke Detector voltage = 17.85 to 26.4 VDC. Max. Ripple = 400 mVDC Max. Alarm Current = 33 mADC. Refer to Compatibility Section. <b>2-Wire Relay Bases are NOT supported.</b>
Supervisory Series & EOL Resistors (P/N 46071-0409 for ULI) (2 each P/N EOL-P1 for ULC)	1.1K $\Omega$ , 1 Watt; 3.6K $\Omega$ , 1/2 Watt;
IDC End-Of-Line Resistor	4.7K $\Omega$ , 1/2 Watt
Max. IDC Circuit Field Wiring Resistance	50 $\Omega$
IAC Circuits	Two Class B (Style Y), optional Class A (Style Z)
IAC Output Power/Ckt	Nominal 24 VDC @ 2.5A; 4.0 Amp total for both zones
IAC EOL	4.7K $\Omega$ , 1/2 Watt
System Alarm Relay	Form C, 24 VDC @1 A. Refer to Compatibility Section for proper installation.
System Trouble Relay	Form C, 24 VDC @1 A. Refer to Compatibility Section for proper installation.
Indicators	Power, System Trouble, Zone Disabled, Alarm Silenced, Alarm, Signal circuit trouble (2), and Ground Fault LEDs

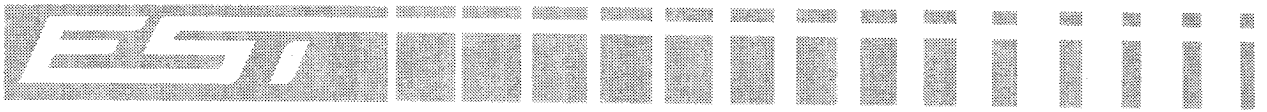

Table 9.1 - Specifications	
Base Panel Assemblies	
Controls	Trouble Silence, Alarm Silence, Reset, and Zone Enable/Disable Switches
Max. Battery Charger Current	500 mADC.
Environment	
Relative Humidity	85% @ 86°F (30°C)
Operating Temperature	32°F to 120°F (0°C to 49°C)

Table 9.2 - Specifications	
BPAC Base Panel Class A (Style D/Z) Converter Module (P/N 46199-1071)	
Expansion Space	None
IDC Wiring	Converts two Style B Circuits into two Style D Circuits
IAC Wiring	Converts two Style Y Circuits into two Style Z Circuits
Weight	0.4 lbs (0.18 Kg)

Table 9.3 - Specifications	
2IDC IDC Module (P/N 240456)	
Expansion Space	1
IDC Zones	Two Style B, verification optional
Detector Capacity per IDC Circuit	30 - Photoelectric Smoke 50 - Ionization Smoke Detector voltage = 17.85 to 26.4 VDC. Max. Ripple = 400 mVDC. Max. Alarm Current = 33 mADC. <b>Refer to Compatibility Section. Relay Bases are NOT supported.</b>
IDC EOL	4.7K $\Omega$ , 1/2 Watt
Max. Circuit Resistance	50 $\Omega$
Indicators and Controls	Trouble LED Enable/Disable Switch
Weight	0.3 lbs (0.14 Kg)

Table 9.4 - Specifications	
IDCA IDC Class A (Style D) Zone Converter Module (P/N 46199-1073)	
Expansion Space	None
IDC Wiring	Two Class A (Style D) Circuits
Weight	0.3 lbs (0.14 Kg)

Table 9.5 - Specifications	
RCT-1 Relay/City-Tie Module (P/N 240511)	
Expansion Space	1
Configurable Operation	Reset, Alarm, Trouble, or Supervisory
Master Box Operation	Nominal 24 VDC
Max. Wiring Resistance	25 $\Omega$
Trip Current	200 mA into 14.5 $\Omega$ coil
Reverse Polarity Operation	Nominal 24 VDC
Loop and Receiver Resistance	1.5 K $\Omega$ , Max.
Current Range	2.5 to 9.9 mA
Dry Contact (Shunt)	Normally-Open <b>OR</b> Normally-Closed, 24 VDC @ 1 A. Refer to Application Section for proper installation.

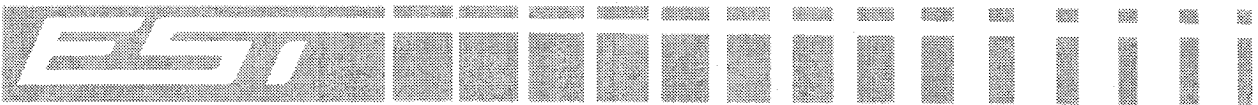

<b>Table 9.5 - Specifications</b>	
<b>RCT-1 Relay/City-Tie Module (P/N 240511)</b>	
Indicators and Controls	Trouble LED Enable/Disable Switch
Weight	0.4 lbs (0.18 Kg)

<b>Table 9.6 - Specifications</b>	
<b>ADMM Annunciator Driver Master Module (P/N 240460)</b>	
Expansion Space	1
Circuit Rating	30 V @ 15 mA Max.
Weight	0.4 lbs (0.18 Kg)

<b>Table 9.7 - Specifications</b>	
<b>ADSM Annunciator Driver Slave Module (P/N 240462)</b>	
Expansion Space	0
Circuit Rating	30 V @ 15 mA Max.
Weight	0.3 lbs (0.14 Kg)

<b>Table 9.8 - Specifications</b>		
<b>Remote Annunciators</b>		
Wiring		22 AWG, Min.
Power		24 VDC, Nominal
Model	Supervisory Current	Alarm Current
RTU(C)	10 mA	10 mA
RTU4ZA(C)	11 mA	11 mA + 11 mA/ Active zone LED
RTU8ZA(C)	12 mA	12 mA + 11 mA/ Active zone LED
4ZA(C)	1 mA	1 mA + 11 mA/ Active zone LED
8ZA(C)	2 mA	2 mA + 11 mA/ Active zone LED

(C) = French/English bilingual version

<b>Table 9.9 - Specifications</b>	
<b>BC-2 Battery Cabinet</b>	
Wiring	5 Ft (1.52 M) Max. 16 AWG Min.
Battery Type	2 x 12 V, 10 AH, Lead-Acid
Dimensions (HWD)	
Back box	13" x 20.19" x 2.75" [33.0 cm x 51.3 cm x 7.0 cm]
Finished	15" x 22" x 1.125" [38.1 cm x 55.9 cm x 2.9 cm]

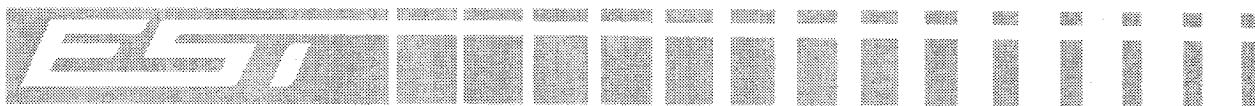

**Table 9.10- Specifications**

<b>DL1 Dialer Module</b>	
Expansion Space	1
Phone Line:	Two Loop Start lines on Public switched telephone network, Pulse or DTMF dialing.
Wall Connector	Standard RJ-31X jack
Line Supervision	Trouble when line voltage < 10 V & line current < 5 mA.
Communications Protocol	SIA pulse format P3, 20 PPS, 3/2 or 4/2, double round, 1400 Hz handshake, 1900 Hz carrier
Telephone Numbers	Two, 24 digit numbers
FCC Registration Number	4Z2USA-22549-AL-E
Dialing Retries	5 to 10
AC Power Failure Delay	0 to 18 hours
Clock Accuracy	Within one hour/year
Compliance	Communications Canada CS-03 FCC / CFR 47 Parts 15 & 68 NFPA 72; UL 864; ULC S527-M87 FM
Programming Phone	Any Tone dial (DTMF) Phone with RJ11 plug
Weight	0.4 lbs (0.18 Kg)

<b>DL1 Dialer Codes</b>					
<b>Event Condition</b>		<b>Event Code</b>	<b>Event Condition</b>		<b>Event Code</b>
Zone 1	Alarm	11	Zone 6	Alarm	61
	Supervisory Alarm	12		Supervisory Alarm	62
	Trouble	13		Trouble	63
	Restore	14		Restore	64
	Supervisory Restore	15		Supervisory Restore	65
Zone 2	Alarm	21	Zone 7	Alarm	71
	Supervisory Alarm	22		Supervisory Alarm	72
	Trouble	23		Trouble	73
	Restore	24		Restore	74
	Supervisory Restore	25		Supervisory Restore	75
Zone 3	Alarm	31	Zone 8	Alarm	81
	Supervisory Alarm	32		Supervisory Alarm	82
	Trouble	33		Trouble	83
	Restore	34		Restore	84
	Supervisory Restore	35		Supervisory Restore	85
Zone 4	Alarm	41	Panel	Normal 24 Hr. Check in	90
	Supervisory Alarm	42		Trouble	93
	Trouble	43		Restore	94
	Restore	44		AC Power Fail	96
	Supervisory Restore	45		Abnormal 24 Hr Check in	97
Zone 5	Alarm	51	Telephone Line trbl	98	
	Supervisory Alarm	52	Dialer Disabled	99	
	Trouble	53			
	Restore	54			
	Supervisory Restore	55			



## 10.0 APPENDICES

### 10.1 Appendix 1 - Battery Calculations

Maximum internal battery size is 8 AH. Maximum battery size with optional BC-2 Battery Cabinet is 10 AH. Refer to Replacement Parts Section for part numbers.

There are *two* methods of determining the correct battery capacity required for a given panel configuration and the required supervisory and alarm times:

- The battery tables allow quick battery selection. The tables offer a worst case solution. When the tables indicate a battery requirement which forces the use of the next size larger battery, using the battery calculation worksheets may be advantageous.
- When the panel parameters don't fit the tables, or when more accurate calculations are desired, use the worksheet method. The worksheets yield a more precise answer, which may be slightly lower than the worst case values.

#### Battery Tables

Three pairs of battery tables are provided for the three most common Supervisory and Alarm Time combinations. For instructions on using the battery tables, refer to the section entitled **Using the Battery Tables**.

**Table 10.1 - 24 Hours Supervisory, 5 Minutes of Alarm**

Panel Current Load									Auxiliary Power Load						
# Option Modules	IAC Alarm Current (A)								Auxiliary Power Supervisory Current (mA)	Auxiliary Power Alarm Current (mA)					
	0.5	1.0	1.5	2.0	2.5	3.0	3.5	4.0		0	100	200	300	400	500
0	1.7	1.8	1.8	1.9	2.0	2.1	2.2	2.3	0	0.0	0.0	0.0	0.1	0.1	0.1
1	2.1	2.2	2.3	2.4	2.4	2.5	2.6	2.7	25	0.7	0.7	0.7	0.7	0.7	0.8
2	2.5	2.6	2.7	2.8	2.9	3.0	3.0	3.1	50	1.3	1.4	1.4	1.4	1.4	1.4
3	3.0	3.1	3.1	3.2	3.3	3.4	3.5	3.6	75	2.0	2.0	2.0	2.1	2.11	2.1
4	3.4	3.5	3.6	3.7	3.7	3.8	3.9	4.0	100	2.7	2.7	2.7	2.7	2.7	2.8
5	3.8	3.9	4.0	4.1	4.2	4.2	4.3	4.4	125	3.3	3.4	3.4	3.4	3.4	3.4
6	4.3	4.3	4.4	4.5	4.6	4.7	4.8	4.8	150	4.0	4.0	4.0	4.1	4.1	4.1

**Table 10.2 - 24 Hours Supervisory, 30 Minutes of Alarm**

Panel Current Load									Auxiliary Power Load						
# Option Modules	IAC Alarm Current (A)								Auxiliary Power Supervisory Current (mA)	Auxiliary Power Alarm Current (mA)					
	0.5	1.0	1.5	2.0	2.5	3.0	3.5	4.0		0	100	200	300	400	500
0	2.1	2.6	3.1	3.6	4.1	4.6	5.1	5.6	0	0.0	0.1	0.1	0.2	0.3	0.3
1	2.5	3.0	3.5	4.0	4.5	5.0	5.5	6.0	25	0.7	0.7	0.8	0.9	0.9	1.0
2	3.0	3.5	4.0	4.5	5.0	5.5	6.0	6.5	50	1.3	1.4	1.5	1.5	1.6	1.7
3	3.4	3.9	4.4	4.9	5.4	5.9	6.4	6.9	75	2.0	2.1	2.1	2.2	2.3	2.3
4	3.8	4.3	4.8	5.3	5.8	6.3	6.8	7.3	100	2.7	2.7	2.8	2.9	2.9	3.0
5	4.3	4.8	5.3	5.8	6.3	6.8	7.3	7.8	125	3.3	3.4	3.5	3.5	3.6	3.7
6	4.7	5.2	5.7	6.2	6.7	7.2	7.7	8.2	150	4.0	4.1	4.1	4.2	4.3	4.3

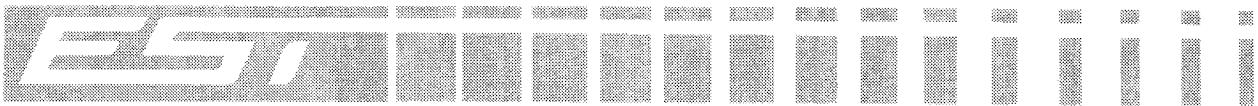

**Table 10.3 - 60 Hours Supervisory, 5 Minutes of Alarm**

Panel Current Load										Auxiliary Power Load						
# Option Modules	IAC Alarm Current (A)									Auxiliary Power Supervisory Current (mA)	Auxiliary Power Alarm Current (mA)					
	0.5	1.0	1.5	2.0	2.5	3.0	3.5	4.0	0		100	200	300	400	500	
0	4.1	4.2	4.2	4.3	4.4	4.5	4.6	4.7		0.0	0.0	0.0	0.1	0.1	0.1	
1	5.1	5.2	5.3	5.4	5.5	5.6	5.6	5.7		1.7	1.7	1.7	1.7	1.7	1.8	
2	6.2	6.3	6.4	6.5	6.5	6.6	6.7	6.8		3.3	3.4	3.4	3.4	3.4	3.4	
3	7.3	7.3	7.4	7.5	7.6	7.7	7.8	7.8		4.5	4.5	4.5	4.5	4.5	4.5	
4	8.3	8.4	8.5	8.6	8.6	8.7	8.8	8.9								
5	9.5	9.5	9.6	9.7	9.8	9.9	9.9	10.0								

**Using the Battery Tables**

Having selected the proper pair of tables, you must know the number of option modules installed in the panel, the total IAC current required, and any auxiliary current required. Option modules are 2IDC Two Zone Initiating Device Circuit Modules, RCT-1 Relay/City-Tie, and ADMM Annunciator Driver Master Modules. BPAC Class A Converters, IDCA Class A IDC Converters, and ADSM Annunciator Driver Slave Modules are NOT considered in the module count.

1. In the appropriate **Panel Current Load** Table, select the first column with an alarm current equal to or greater than the total indicating appliance load.
2. In that column, circle the value which intersects the row representing the number of modules in your system.
3. In the corresponding **Auxiliary Power Load** Table, select the first column with an auxiliary power *alarm* current equal to or greater than the total auxiliary power alarm current load. Remember to include remote annunciator current.
4. In that column, circle the value which intersects the row representing the auxiliary power *supervisory* current in your system.
5. Add the two circled values together to determine the minimum amp-hour (AH) battery capacity required.
6. Select a battery combination with an amp-hour (AH) rating of equal or greater value.

**Battery Calculation Example #1**

A panel with one option module is to be installed in accordance with the Canadian National Building Code (NBC) requirement of 24 hours standby, 30 minutes alarm. The IAC requires 2.5 Amps, and there is no auxiliary power used. Calculate the minimum required battery capacity that will meet the requirements. Looking at Table 10.2, the intersection of the one (1) option module row and the 2.5A IAC alarm current column occurs at 4.5. Since there is no auxiliary power requirement, the required battery capacity is 4.5 AH. Two 12 V, 6.5 AH batteries (P/N 12V6A5) will adequately power this system.

**Table 10.2 (EXAMPLE #1)  
24 Hours Supervisory  
30 Minutes of Alarm**

Panel Current Load									
# Option Modules	IAC Alarm Current (A)								
	0.5	1.0	1.5	2.0	2.5	3.0	3.5	4.0	
0	2.1	2.6	3.1	3.6	4.1	4.6	5.1	5.6	
1	2.5	3.0	3.5	4.0	4.5	5.0	5.5	6.0	
2	3.0	3.5	4.0	4.5	5.0	5.5	6.0	6.5	
3	3.4	3.9	4.4	4.9	5.4	5.9	6.4	6.9	
4	3.8	4.3	4.8	5.3	5.8	6.3	6.8	7.3	
5	4.3	4.8	5.3	5.8	6.3	6.8	7.3	7.8	
6	4.7	5.2	5.7	6.2	6.7	7.2	7.7	8.2	

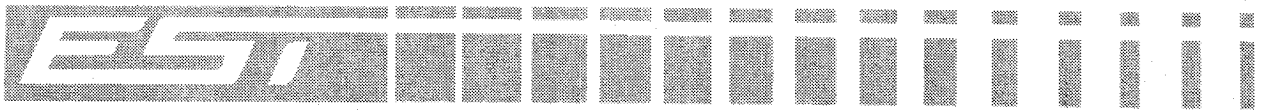

**Battery Calculation Example #2**

A panel with two option modules requires 24 hours of standby, 5 minutes alarm. The IAC requires 2.5 Amps. The remote trouble unit to be installed with the panel requires 15 mA of supervisory current and 15 mA in the Alarm mode. Calculate the minimum required battery capacity that will meet these requirements. Looking at Table 10.1, the intersection of the two (2) option module row and the 2.5A IAC alarm current column occurs at 2.9. The intersection of the 15 mA supervisory current row (25 mA heading) and the 15 mA supervisory alarm current column (100 mA heading) occurs at 0.7. Adding the values of the two table intersections together (2.9 + 0.7 = 3.6), the required battery capacity is 3.6 AH. Two 12 V, 6.5 AH batteries (P/N 12V6A5) will adequately power this system.

**Table 10.1 (EXAMPLE #2) - 24 Hours Supervisory, 5 Minutes of Alarm**

Panel Current Load									Auxiliary Power Load						
# Option Modules	IAC Alarm Current (A)								Auxiliary Power Supervisory Current (mA)	Auxiliary Power Alarm Current (mA)					
	0.5	1.0	1.5	2.0	2.5	3.0	3.5	4.0		0	100	200	300	400	500
0	1.7	1.8	1.8	1.9	2.0	2.1	2.2	2.3	0	0.0	0.0	0.0	0.1	0.1	0.1
1	2.1	2.2	2.3	2.4	2.4	2.5	2.6	2.7	25	0.7	0.7	0.7	0.7	0.7	0.8
2	2.5	2.6	2.7	2.8	2.9	3.0	3.0	3.1	50	1.3	1.4	1.4	1.4	1.4	1.4
3	3.0	3.1	3.1	3.2	3.3	3.4	3.5	3.6	75	2.0	2.0	2.0	2.1	2.11	2.1
4	3.4	3.5	3.6	3.7	3.7	3.8	3.9	4.0	100	2.7	2.7	2.7	2.7	2.7	2.8
5	3.8	3.9	4.0	4.1	4.2	4.2	4.3	4.4	125	3.3	3.4	3.4	3.4	3.4	3.4
6	4.3	4.3	4.4	4.5	4.6	4.7	4.8	4.8	150	4.0	4.0	4.0	4.1	4.1	4.1

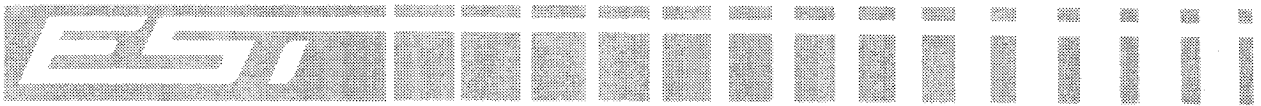

### Battery Calculation Worksheets

If the panel parameters exceed the values in the battery calculation tables, or if detailed battery calculations are required, the battery calculation worksheets should be used.

1. Enter the quantity of each module installed in the "Quantity" column, next to the appropriate module description.
2. For each quantity entry, multiply the value in the "Quantity" column by the value in the "Supervisory" column, and enter the value in the "Total Supervisory" column.
3. For each quantity entry, multiply the value in the "Quantity" column by the value in the "Alarm" column, and enter the value in the "Total Alarm" column.
4. Add all values in the "Total Supervisory" column and put the answer in the Total Supervisory box "A".
5. Add all values in the "Total Alarm" column and put the answer in the Total Alarm box "B".
6. Enter the required supervisory time (hours) in box "C", and the total alarm time (minutes) in the alarm time box "D".
7. Substitute the values from boxes "A" through "D" in the battery calculation formula, and calculate the minimum battery capacity.

Description	Quantity	Supervisory (mA)	Total Supervisory (mA)	Alarm	Total Alarm
Base Panel	1	x 55	55	100	100
2 Zone input module		x 16		45	
Relay Modules		x 16		76	
Dialer		x 12		25	
Style D IDC Converter		0	0	40	
Annunciator Master		x 10		100	
Remote Trouble Unit		x 10		10	
Auxiliary Power (mA)					
Number of Detectors		0.050			
Signal Load (mA)					
TOTAL			(A)		(B)
Battery Calculation					
Supervisory Hours		(C)			
Alarm Minutes		(D)			

$$\text{Battery Capacity (A.H.)} = \frac{(1.11 \times A \times C) + (0.033 \times B \times D)}{1000}$$

NOTE: Battery capacity of panel can be extended to 10 AH using the BC-2 Battery Cabinet



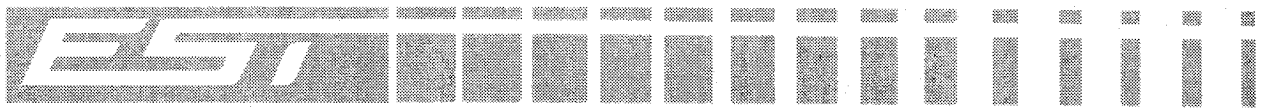

### Battery Calculation Example #3

A panel with two (2) Two Zone Initiating Device Circuit Modules requires 24 hours standby, 5 minutes alarm. The Indicating Appliance Circuit requires 2.5 Amps. The remote trouble unit to be installed with the panel requires 15 mA in the Supervisory mode and 15 mA in the Alarm mode. Calculate the minimum required battery capacity that will meet these requirements.

Description	Quantity		Supervisory (mA)	Total Supervisory (mA)	Alarm	Total Alarm
Base Panel	1	x	55	55	100	100
2 Zone input module	2	x	16	32	45	90
Relay Modules		x	16		76	
Style D IDC Converter			0	0	40	
Dialer		x	12		25	
Annunciator Master		x	10		100	
Remote Trouble Unit	1	x	10	10	10	10
Auxiliary Power (mA)						
Number of Detectors	60		0.050	3.0		3.0
Signal Load (mA)						2,500
			TOTAL	105 (A)		2,703 (B)
Battery Calculation						
Supervisory Hours	24 (C)					
Alarm Minutes	5 (D)					

Enter the data in the formula and solve the equation.

$$\text{Battery Capacity (A.H.)} = \frac{(1.11 \times 105 \times 24) + (0.033 \times 2,703 \times 5)}{1000}$$

$$= 3.24 \text{ A.H.}$$

NOTE: Battery capacity of panel can be extended to 10 AH using the BC-2 Battery Cabinet.

Two 12V, 6.5 AH batteries (P/N 12V6A5) will adequately power this system. Note that this is the same sample problem as Example #2. In this case, however, the answer provided by using the worksheets is only slightly lower than the answer provided by using the tables.

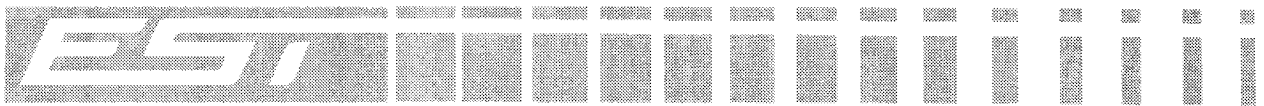

### Battery Calculation Example #4

A panel with a Two Zone Initiating Device Circuit Module is to be installed in accordance with the Canadian National Building Code (NBC) requirement of 24 hours standby, 30 minutes alarm. The Indicating Appliance Circuit requires 2.5 Amps, and there is no auxiliary power used. Calculate the minimum required battery capacity that will meet these requirements.

Description	Quantity		Supervisory (mA)	Total Supervisory (mA)	Alarm	Total Alarm
Base Panel	1	x	55	55	100	100
2 Zone input module	1	x	16	16	45	45
Relay Modules		x	16		76	
Style D IDC Converter			0	0	40	
Dialer		x	12		25	
Annunciator Master		x	10		100	
Remote Trouble Unit		x	10		10	
Auxiliary Power (mA)						
Number of Detectors	20		0.050	1.0		1.0
Signal Load (mA)						2,500
			TOTAL	72 (A)		2,646 (B)
Battery Calculation						
Supervisory Hours	24 (C)					
Alarm Minutes	30 (D)					

Enter the data in the formula and solve the equation.

$$\text{Battery Capacity (A.H.)} = \frac{(1.11 \times 72 \times 24) + (0.033 \times 2,646 \times 30)}{1000}$$

$$= 4.5 \text{ A.H.}$$

NOTE: Battery capacity of panel can be extended to 10 AH using the BC-2 Battery Cabinet.

Two 12 V, 6.5 AH batteries (P/N 12V6A5) will adequately power this system. Note that this is the same sample problem as Example #1. In this case, the answer provided by using the worksheets is the same as the answer provided by using the tables.

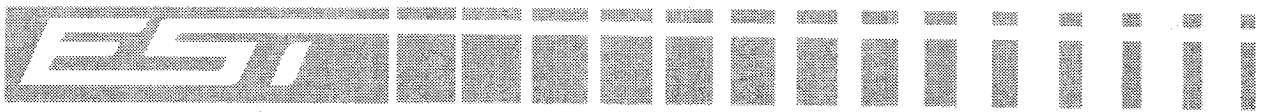

## 10.2 Appendix 2 - Compatible Devices

### ULI Compatibility Listings

Compatible devices listed in this section are for use in the **USA ONLY**.

Compatible devices listed by GS Building Systems Corporation.

**Table 10.4 - ULI Control Unit Compatibility Specifications - EST**

Device	UL Smoke Detector Compatibility ID	Electrical Data				EOL
		Standby Voltage @ Detector	Ripple Voltage	Maximum Standby Detector Load		
				Style B	Style D	
EST1-2Z3 EST1-2Z3-220 2 zone-3 space panel	0.0	17.85 -26.4 VDC	400 mV	2.5 mA @ 22.3 VDC	N/A	4.7KΩ P/N 46229-0107
EST1-2Z6 EST1-2Z6-220 2 zone-6 space panel	0.0	17.85 -26.4 VDC	400 mV	2.5 mA @ 22.3 VDC	N/A	4.7KΩ P/N 46229-0107
2IDC 2 Zone IDC Module (P/N 240456)	0.0	17.85 -26.4 VDC	400 mV	2.5 mA @ 22.3 VDC	N/A	4.7KΩ P/N 46229-0107
BPAC Base Panel Class A Converter (P/N 46199-1071)	0.0	17.85 -26.4 VDC	400 mV	N/A	2.5 mA @ 22.3 VDC	N/A
IDCA IDC Converter (P/N 46199-1073)	0.0	17.85 -26.4 VDC	400 mV	N/A	2.5 mA @ 22.3 VDC	N/A

**Table 10.5 - ULI Compatible Receivers for the DL1 Dialer Module**

Model	Manufacturer	Location
685	Alarm Device Manufacturing Co., Div. of Pittway Corp.	Syosset, NY 11791
CP220	Fire Burglary Instruments, Div. of Pittway Corp.	Syosset, NY 11791
Quick Alert II	Osborne - Hoffman Inc.	Point Pleasant Beach, NJ 08742
D6500	Radionics Inc.	Salinas, CA 93912
9000	Silent Knight Security Systems, Div. of Willknight Inc.	Maple Grove, MN 55369

**Table 10.6 - ULI Device & Panel Compatibility - Initiating Devices**

Cat. #	Description	UL Identifier	Max. # Devices per IDC Zone	Notes
291B	135°F (57°C) Heat Detector	NA	50	1,6
292B	197°F (92°C) Heat Detector	NA	50	1,6
293B	135°F (57°C) Heat Detector	NA	50	1,6
294B	197°F (92°C) Heat Detector	NA	50	1,6
5956A	Fire Alarm Indicator - LED	NA	NA	
6249B	Ionization Smoke Detector c/w Base	001	50	4
6250B	Ionization Smoke Detector	001	50	1,4,6
6260A-100	Duct Detector/Sensor Housing (housing only)	NA	NA	
6262A-001	Fire Alarm Indicator/Test Station	NA	NA	
6264B-001	Ionization Detector, Duct	001	50	1,2,4,6
6266B-001	Photoelectric Detector, Duct	001	30	1,2,4,6
6269B	Photoelectric Smoke Detector c/w Base	001	30	4
6269B-003	Photoelectric/Heat Detector c/w Base	001	30	4
6270B	Photoelectric Smoke Detector	001	30	1,4,6
6270B-003	Photoelectric/Heat Detector	001	30	1,4,6
6424	Beam Smoke Detector - 4 wire	NA	NA	3



**NOTES**

1. These detectors plug into the following base: Cat.# 6251B-001A. Compatibility ID for all bases is 001. The Cat.# 5956A remote LED may also be used with these bases.
2. These detectors are used with the following detector housing: Cat.# 6260A-100. The Cat.# 6262A-001 Alarm Indicator/Test Station may also be used with these bases and the Cat.# 6260A-100 Duct Detector Housing.
3. The Cat.# 6424 Beam Smoke Detector is powered from auxiliary power.
4. Low impedance detectors. (Refer to Programming Section for proper operation.)
5. High impedance detectors. (Refer to Programming Section for proper operation.)
6. These detectors may use the Cat.# 6251B-003 relay base when used in the 4-wire configuration. The relay is then powered from auxiliary power and must be included in auxiliary power alarm current calculations. See the battery calculations section and the **CONTROL PANEL APPLICATIONS 2** drawing.

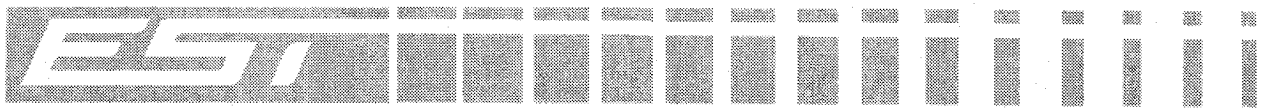

**Table 10.7 - ULI Compatible Signaling Appliances**

Cat.#	Description	Cat.#	Description
202-2B-001	0.8cd Wall Strobe, Red	5520D-AW	Horn/Siren
202-2B-101	0.8cd Wall Strobe, Beige	5522D-AW	Explosionproof Horn
202-2B-011	0.8cd Ceiling Strobe, Red	5523D-AW	Explosionproof Siren
202-2B-101	0.8cd Wall Strobe, Beige	5524D-AW	Explosionproof Horn
202-2B-111	0.8cd Ceiling Strobe, Beige	5525D-AW	Explosionproof Siren
202-6B-001	15cd Wall Strobe, Red	5530D-AW	Multi-Tone Signal
202-3A-T	30cd Synchronized Strobe	5533D-AW	Explosionproof Multi-Tone Signal
202-3A-TW	30cd Synchronized Strobe	5534D-AW	Explosionproof Multi-Tone Signal
202-5A-T	15cd Synchronized Strobe	682-1A-HR	Mini Horn
202-5A-TW	15cd Synchronized Strobe	682-1A-HW	Mini Horn
202-6A-T	60cd Synchronized Strobe	682-1B-002	Horn, Red
202-6A-TW	60cd Synchronized Strobe	682-1B-102	Horn, Beige
202-6B-011	15cd Ceiling Strobe, Red	682-1B-012	Horn w/LED, Red
202-6B-101	15cd Wall Strobe, Beige	682-1B-112	Horn w/LED, Beige
202-6B-111	15cd Ceiling Strobe, Beige	692-2B-003	0.8cd Strobe/Horn, Red
202-7A-001	15cd Ceiling Strobe, Red	692-2B-103	0.8cd Strobe/Horn, Beige
202-7A-101	15cd Strobe, Beige	692-3A-HSR	30cd Synchronized Mini Horn/Strobe
202-7A-T	15/75cd Synchronized Strobe	692-3A-HSW	30cd Synchronized Mini Horn/Strobe
202-7A-TW	15/75cd Synchronized Strobe	692-5A-HSR	15cd Synchronized Mini Horn/Strobe
202-8A-001	110cd Strobe, Red	692-5A-HSW	15cd Synchronized Mini Horn/Strobe
202-8A-101	110cd Strobe, Beige	692-6B-003	15cd Strobe/Horn, Red
202-8A-T	110cd Synchronized Strobe	692-6B-103	15cd Strobe/Horn, Beige
202-8A-TW	110cd Synchronized Strobe	692-7A-003	75cd Strobe/Horn, Red
		692-7A-103	75cd Strobe/Horn, Beige
323D-10AW	Single Stroke Bell, Gray	692-7A-HSR	15/75cd Synchronized Mini Horn/Strobe
323D-10AW-R	Single Stroke Bell, Red	692-7A-HSW	15/75cd Synchronized Mini Horn/Strobe
329D-AW	Single Stroke Chime	692-8A-003	110cd Strobe/Horn, Red
		692-8A-103	110cd Strobe/Horn, Beige
403-3A-R	30cd Synchronized Bell/Strobe Plate	692-8A-HSR	110cd Synchronized Mini Horn/Strobe
403-5A-R	15cd Synchronized Bell/Strobe Plate	692-8A-HSW	110cd Synchronized Mini Horn/Strobe
403-7A-R	15/75cd Synchronized Bell/Strobe		
403-8A-R	110cd Synchronized Bell/Strobe	732-7A-006	15cd Strobe/Chime, Red
405-3A-T	30cd Synchronized Strobe	732-7A-106	15cd Strobe/Chime, Beige
405-3A-TW	30cd Synchronized Strobe	732-8A-106	110cd Strobe/Chime, Beige
405-5A-T	15cd Synchronized Strobe	757-1A-C	Chime
405-5A-TW	15cd Synchronized Strobe	757-3A-CS	30cd Synchronized Chime/Strobe
405-6A-T	60cd Synchronized Strobe	757-3A-CSW	30cd Synchronized Chime/Strobe
405-6A-TW	60cd Synchronized Strobe	757-5A-CS	15cd Synchronized Chime/Strobe
405-7A-T	15/75cd Synchronized Strobe	757-5A-CSW	15cd Synchronized Chime/Strobe
405-7A-TW	15/75cd Synchronized Strobe	757-7A-CS	15/75cd Synchronized Chime/Strobe
405-8A-T	110cd Synchronized Strobe	757-7A-CSW	15/75cd Synchronized Chime/Strobe
405-8A-TW	110cd Synchronized Strobe	757-8A-CS	110cd Synchronized Chime/Strobe
439D-6AW	6" Vibrating Bell, Gray	757-8A-CSW	110cd Synchronized Chime/Strobe
439D-6AW-R	6" Vibrating Bell, Red	757-1A-H	Horn
439D-8AW	8" Vibrating Bell, Gray	757-1A-HW	Horn
439D-8AW-R	8" Vibrating Bell, Red	757-3A-HS	30cd Synchronized Horn/Strobe
439D-10AW	10" Vibrating Bell, Gray	757-3A-HSW	30cd Synchronized Horn/Strobe
439D-10AW-R	10" Vibrating Bell, Red	757-5A-HS	15cd Synchronized Horn/Strobe
439DEX-6AW	6" Explosion Proof Bell	757-5A-HSW	15cd Synchronized Horn/Strobe
439DEX-8AW	8" Explosion Proof Bell	757-7A-HS	15/75cd Synchronized Horn/Strobe
439DEX-10AW	10" Explosion Proof Bell	757-7A-HSW	15/75cd Synchronized Horn/Strobe
		757-8A-MTW	110cd Master Synchronized Temporal Horn/Strobe

**Table 10.7 - ULI Compatible Signaling Appliances**

Cat.#	Description	Cat.#	Description
762-8A-006	110cd Strobe/Chime, Red	922-1B-222	Chime
792-7A-006	75cd Strobe/Horn, Red	932-2B-222	0.8cd Strobe/Chime
792-7A-106	75cd Strobe/Horn, Beige	932-6B-222	15cd Strobe/Chime
792-8A-106	110cd Strobe/Horn, Beige	97DEXC-G1	Explosionproof Strobe, Clear
		97DEXR-G1	Explosionproof Strobe, Red
822-1B-102	Chime, Beige		
832-2B-002	0.8cd Strobe/Chime, Red		
832-2B-102	0.8cd Strobe/Chime, Beige		
832-6B-002	15cd Strobe/Chime, Red		
832-6B-102	15cd Strobe/Chime, Beige		
882-2B-001	Horn, Red		
882-2B-002	Horn w/Terminals, Red		
882-2B-101	Horn, Beige		
882-2B-102	Horn w/Terminals, Beige		
889D-AW	Explosionproof Horn		
890RDA	Wall Lamp Station, Red		
891RD	Lamp/Horn Station		
892-2B-001	0.8cd Strobe/Horn w/Leads, Red		
892-2B-002	0.8cd Strobe/Horn w/Terminals, Red		
892-2B-101	0.8cd Strobe/Horn w/Leads, Beige		
892-2B-102	0.8cd Strobe/Horn w/Terms, Beige		
892-6B-001	15cd Strobe/Horn w/Leads, Red		
892-6B-002	15cd Strobe/Horn w/Terminals, Red		
892-6B-101	15cd Strobe/Horn w/Leads, Beige		
892-6B-102	15cd Strobe/Horn w/Terminals, Beige		

**Table 10.8 - ULI Compatible Accessories**

Cat. Number	Description
*MR-101/C	1-SPDT Relay w/LED
*MR-101/T	1-SPDT Relay w/LED
*MR-104/C	4-SPDT Relay w/LEDs
*MR-104/T	4-SPDT Relay w/LEDs
*MR-201/C	1-DPDT Relay w/LED
*MR-201/T	1-DPDT Relay w/LED
*MR-204/C	4-DPDT Relay w/LEDs
*MR-204/T	4-DPDT Relay w/LEDs
*PAM-1	1-SPDT w/LED, Adhesive Mt.
6254A-003	Fire Alarm/Power Supervision Relay
RTU	Remote Trouble Unit
4ZA	Remote Annunciator, 4 Zone
8ZA	Remote Annunciator, 8 Zone
RTU4ZA	Remote Annunciator, 4 Zone w/ Trouble Unit
RTU8ZA	Remote Annunciator, 8 Zone w/ Trouble Unit

\* = Manufactured by Air Products & Control, Ltd.

Only the devices in Table 10.8 are listed compatible with panel auxiliary power.

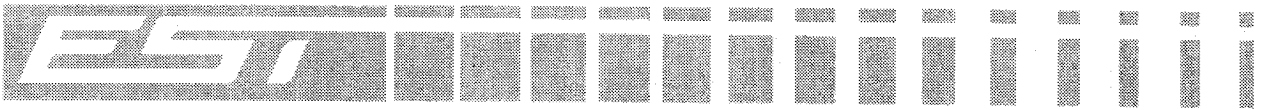

### ULC Compatibility Listings

Compatible devices listed in this section are for use in **CANADA ONLY**.

**Table 10.9 - ULC Control Unit Compatibility Specifications - EST**

Device	ULC Smoke Detector Compatibility ID	Electrical Data				EOL
		Standby Voltage @ Detector	Ripple Voltage	Maximum Standby Detector Load		
				Style B	Style D	
EST1-2Z3 EST1-2Z3-220 2 zone-3 space panel	0.0	17.85 -26.4 VDC	400 mV	2.5 mA @ 22.3 VDC	N/A	4.7KΩ P/N EOL-P1
EST1-2Z6 EST1-2Z6-220 2 zone-6 space panel	0.0	17.85 -26.4 VDC	400 mV	2.5 mA @ 22.3 VDC	N/A	4.7KΩ P/N EOL-P1
2IDC 2 Zone IDC Module (P/N 240456)	0.0	17.85 -26.4 VDC	400 mV	2.5 mA @ 22.3 VDC	N/A	4.7KΩ P/N EOL-P1
BPAC Base Panel Class A Converter (P/N 46199-1071)	0.0	17.85 -26.4 VDC	400 mV	N/A	2.5 mA @ 22.3 VDC	N/A
IDCA IDC Converter (P/N 46199-1073)	0.0	17.85 -26.4 VDC	400 mV	N/A	2.5 mA @ 22.3 VDC	N/A

**Table 10.10 - ULC Compatible Receivers for the DL1 Dialer Module**

Model	Manufacturer	Location
685	Alarm Device Manufacturing Co., Div. of Pittway Corp.	Syosset, NY 11791
CP220	Fire Burglary Instruments, Div. of Pittway Corp.	Syosset, NY 11791
Quick Alert II	Osborne - Hoffman Inc.	Point Pleasant Beach, NJ 08742
D6500	Radionics Inc.	Salinas, CA 93912
9000	Silent Knight Security Systems, Div. of Willknight Inc.	Maple Grove, MN 55369

**Table 10.11 - ULC Device & Panel Compatibility - Initiating Devices**

Cat. #	Description	ULC Identifier	Max. # Devices per IDC Zone	Notes
291C	135°F (57°C) Heat Detector	001	50	1,7
292C	197°F (92°C) Heat Detector	001	50	1,7
293C	135°F (57°C) Heat Detector	001	50	1,7
294C	197°F (92°C) Heat Detector	001	50	1,7
5956A	Fire Alarm Indicator - LED	NA	NA	
6249C	Ionization Smoke Detector c/w Base	001	50	3,5
6250C	Ionization Smoke Detector	001	50	1,5,7
6260A-100	Duct Detector/Sensor Housing (housing only)	NA	NA	
6260C-005	Duct Detector Assembly, Low Velocity	NA	NA	
6262A-001	Fire Alarm Indicator/Test Station	NA	NA	
6264C-001	Ionization Detector, Duct	001	50	1,2,5,7
6264C-005	Ionization Detector, Duct, Low Velocity	001	50	1,2,5,7
6266C-001	Photoelectric Detector, Duct	001	30	1,2,5,7
6269C	Photoelectric Smoke Detector c/w Base	001	30	3,5
6269C-003	Photoelectric/Heat Detector c/w Base	001	30	3,5
6270C	Photoelectric Smoke Detector	001	30	1,5,7
6270C-003	Photoelectric/Heat Detector	001	30	1,5,7
6426A	Beam Smoke Detector - 4-wire	NA	NA	4



**NOTES**

1. These detectors plug into the following base: Cat.# 6251C-001A. Compatibility ID for all bases is 001. The Cat.# 5956A remote LED may also be used with these bases.
2. These detectors are used with the following detector housings: Cat.# 6260A-100 and Cat.# 6260C-005 duct detector assembly and fire alarm indicator/test station.
3. The Cat.# 5956A remote LED may also be used with these bases.
4. The Cat.# 6424A Beam Smoke Detector is powered from auxiliary power.
5. Low impedance detectors. (Refer to Programming Section for proper operation.)
6. High impedance detectors. (Refer to Programming Section for proper operation.)
7. These detectors may use the Cat.# 6251C-003 relay base when used in the 4-wire configuration. The relay is then powered from auxiliary power and must be included in auxiliary power alarm current calculations. See the battery calculations section and the **CONTROL PANEL APPLICATIONS 2** drawing.



**Table 10.12 - ULC Compatible Signaling Appliances**

Cat.#	Description	Cat.#	Description
128D-AWC	Horn, Beige	682-1A-HR	Mini Horn
128D-AWCR	Horn, Red	682-1A-HW	Mini Horn
		692-3A-HSR	30cd Synch. Mini Horn/Strobe
200E-CULC-24	Strobe, Clear	692-3A-HSW	30cd Synch. Mini Horn/Strobe
200E-RULC-24	Strobe, Red	692-5A-HSR	15cd Synch. Mini Horn/Strobe
200E1-CULC-24	Strobe, Clear	692-5A-HSW	15cd Synch. Mini Horn/Strobe
200E1-RULC-24	Strobe, Red	692-7A-003	75cd Strobe/Horn, Red
202-3A-T	30cd Synchronized Strobe	692-7A-103	75cd Strobe/Horn, Beige
202-3A-TW	30cd Synchronized Strobe	692-7A-HSR	15/75cd Synch. Mini Horn/Strobe
202-5A-T	15cd Synchronized Strobe	692-7A-HSW	15/75cd Synch. Mini Horn/Strobe
202-5A-TW	15cd Synchronized Strobe	692-8A-003	120cd Strobe/Horn, Red
202-6A-T	60cd Synchronized Strobe	692-8A-103	120cd Strobe/Horn, Beige
202-6A-TW	60cd Synchronized Strobe	692-8A-HSR	110cd Synch. Mini Horn/Strobe
202-7A-001	75cd Strobe, Red	692-8A-HSW	110cd Synch. Mini Horn/Strobe
202-7A-101	75cd Strobe, Beige		
202-7A-T	15/75cd Synchronized Strobe	732-7A-006	75cd Strobe/Chime, Red
202-7A-TW	15/75cd Synchronized Strobe	732-7A-106	75cd Strobe/Chime, Beige
202-8A-001	120cd Strobe, Red	732-8A-106	120cd Strobe/Chime, Beige
202-8A-101	120cd Strobe, Beige	757-1A-C	Chime
202-8A-T	110cd Synchronized Strobe	757-1A-CW	Chime
202-8A-TW	110cd Synchronized Strobe	757-3A-CS	30cd Synch. Chime/Strobe
		757-3A-CSW	30cd Synch. Chime/Strobe
333D-4G1	Single Stroke Bell, 4"	757-5A-CS	15cd Synch. Chime/Strobe
333D-6G1	Single Stroke Bell, 6"	757-5A-CSW	15cd Synch. Chime/Strobe
333D-10G1	Single Stroke Bell, 10"	757-7A-CS	15/75cd Synch. Chime/Strobe
339D-G1	Single Stroke Chime	757-7A-CSW	15/75cd Synch. Chime/Strobe
		757-8A-CS	110cd Synch. Chime/Strobe
403-3A-R	30cd Synchronized Bell/Strobe	757-8A-CSW	110cd Synch. Chime/Strobe
403-5A-R	15cd Synchronized Bell/Strobe	757-1A-H	Horn
403-7A-R	15/75cd Synchronized Bell/Strobe	757-1A-HW	Horn
403-8A-R	110cd Synchronized Bell/Strobe	757-3A-HS	30cd Synchronized Horn/Strobe
405-3A-T	30cd Synchronized Strobe	757-3A-HSW	30cd Synchronized Horn/Strobe
405-3A-TW	30cd Synchronized Strobe	757-5A-HS	15cd Synchronized Horn/Strobe
405-5A-T	15cd Synchronized Strobe	757-5A-HSW	15cd Synchronized Horn/Strobe
405-5A-TW	15cd Synchronized Strobe	757-7A-HS	15/75cd Synch. Horn/Strobe
405-6A-T	60cd Synchronized Strobe	757-7A-HSW	15/75cd Synch. Horn/Strobe
405-6A-TW	60cd Synchronized Strobe	757-8A-HS	110cd Synchronized Horn/Strobe
405-7A-T	15/75cd Synchronized Strobe	757-8A-HSW	110cd Synchronized Horn/Strobe
405-7A-TW	15/75cd Synchronized Strobe	757-1A-MT	Master Synch. Temporal Horn
405-8A-T	110cd Synchronized Strobe	757-1A-MTW	Master Synch. Temporal Horn
405-8A-TW	110cd Synchronized Strobe	757-3A-MT	30cd Mstr Synch. Temp. Horn/Strobe
439D-6AWC	6" Vibrating Bell	757-3A-MTW	30cd Master Synch. Temp. Horn/Strobe
439D-10AWC	10" Vibrating Bell	757-5A-MT	15cd Master Synch. Temp. Horn/Strobe
439DEX-6AWC	6" Explosionproof Bell	757-5A-MTW	15cd Master Synch. Temp. Horn/Strobe
		757-7A-MT	15/75cd Mstr Synch. Temp. Horn/Strobe
439DEX-10AWC	10" Explosionproof Bell	757-7A-MTW	15/75cd Mstr Synch. Temp. Horn/Strobe
		757-8A-MT	110cd Mstr Synch. Temp. Horn/Strobe
5520D-G1	Horn/Siren	757-8A-MTW	110cd Mstr Synch. Temp. Horn/Strobe
5524D-G1	Explosionproof Horn	792-7A-106	75cd Strobe/Horn, Beige
5525D-G1	Explosionproof Siren	792-8A-106	120cd Strobe/Horn, Beige
5530D-AWC	Multi-Tone Signal	882-2C-001	Horn w/leads, Red
		889D-AWC	Explosionproof Horn

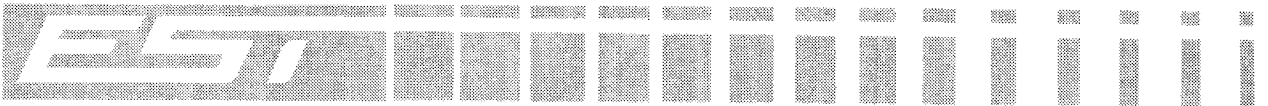

<b>Table 10.13 - ULC Compatible Accessories</b>	
<b>Cat. Number</b>	<b>Description</b>
MR-101/C	1-SPDT Relay w/LED
MR-101/T	1-SPDT Relay w/LED
MR-104/C	4-SPDT Relay w/LEDs
MR-104/T	4-SPDT Relay w/LEDs
MR-201/C	1-DPDT Relay w/LED
MR-201/T	1-DPDT Relay w/LED
MR-204/C	4-DPDT Relay w/LEDs
MR-204/T	4-DPDT Relay w/LEDs
PAM-1	1-SPDT w/LED, Adhesive Mt.
RTU(C)	Remote Trouble Unit
4ZA(C)	4 Zone Annunciator
8ZA(C)	8 Zone Annunciator
RTU4ZA(C)	4 Zone Annunciator, w/ Trouble Unit
RTU8ZA(C)	8 Zone Annunciator, w/ Trouble Unit
6254A-003	Fire Alarm/Power Supervision Relay
1598D-1FG1	1 Face English Fire Sign
1598D-F1FG1	1 Face French Fire Sign
1598D-2FG1	2 Face English Fire Sign
1598D-F2FG1	2 Face French Fire Sign
7651-9	Corridor Lamp, Red
7651-AQ	Corridor Lamp, Red

(C) = French/English bilingual version

Only the devices in Table 10.13 are listed compatible with panel auxiliary power.

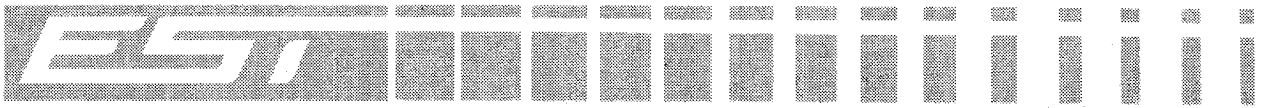

**Table 10.14 Mixed Ion/Photo Detector Maximum Devices per Circuit**  
Refer to Compatibility Tables 10.5 & 10.9

ION Detectors	PHOTO Detectors
0	30
1	29
2	28
3	28
4	27
5	27
6	26
7	25
8	25
9	24
10	24
11	23
12	22
13	22
14	21
15	21
16	20
17	19
18	19
19	18
20	18
21	17
22	16
23	16
24	15
25	15
26	14
27	13
28	13
29	12
30	12
31	11
32	10
33	10
34	9
35	9
36	8
37	7
38	7
39	6
40	6
41	5
42	4
43	4
44	3
45	3
46	2
47	1
48	1
49	
50	

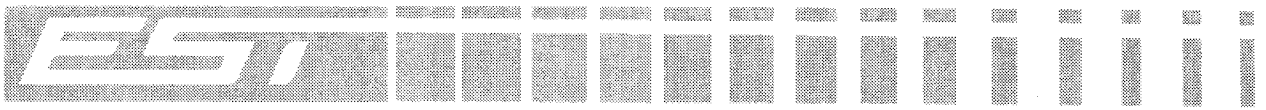

### 10.3 Appendix 3 - Glossary

**Alarm Silence/Reset Inhibit Timer** - A panel option which prevents silencing Indicating Appliance Circuits or resetting the panel for a programmed period after the last alarm.

**Alarm Silence Timer** - A panel option which automatically silences the Indicating Appliance Circuits (IACs) after a programmed time limit after the last alarm.

**Alert** - A condition or state of an Initiating Device Circuit (IDC) caused when the effective internal resistance of an initiating device is a relatively low impedance.

**Alarm** - A condition or state of an Initiating Device Circuit (IDC) caused when the effective internal resistance of an initiating device is approaching  $0\Omega$ .

**Class A Supervision, IAC** - Circuit monitoring technique which signals a trouble condition upon an *open* or *short* condition on an Indicating Appliance Circuit. All appliances can operate in spite of an open fault. Similar to Style Z supervision.

**Class A Supervision, IDC** - Circuit monitoring technique which signals a trouble condition upon an *open* condition on an Initiating Device Circuit. All devices can initiate an alarm in the event of an open fault.

**Class B Supervision, IAC** - Circuit monitoring technique which signals a trouble condition upon an *open* or *short* condition on an Indicating Appliance Circuit. Similar to Style Y supervision.

**Class B Supervision, IDC** - Circuit monitoring technique which signals a trouble condition upon an *open* condition on an Initiating Device Circuit. All devices up to the location of an open fault can initiate an alarm.

**Dialer** - See digital alarm communicator transmitter.

**Digital Alarm Communicator Receiver (DACR)** - Central monitoring station equipment which receives and displays messages from a digital alarm communicator transmitter (DACT) which are sent via the public switched telephone network.

**Digital Alarm Communicator Transmitter (DACT)** - Equipment installed in the fire alarm panel which transmits status changes to the central monitoring station by seizing a telephone line, dialing the preselected number of the digital alarm communicator and transmit fire alarm panel status changes.

**High Impedance Device** - An alarm initiating device whose equivalent resistance will put an Initiating Device Circuit in the Alert mode.

**Indicating Appliance Circuit (IAC)** - A supervised output circuit connected directly to any audible or visual signal appliance used to indicate a fire.

**Initiating Device Circuit (IDC)** - A supervised input circuit connected directly to any manual or automatic initiating device whose normal operation results in an alarm or supervisory signal indication at the control panel.

**Low Impedance Device** - An alarm initiating device whose equivalent resistance will put an Initiating Device Circuit in the Alarm mode.

**March Time** - A 50% duty cycle, 120 beats/minute signal pattern.

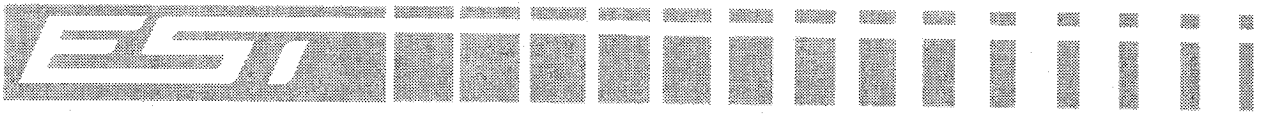

**Non-Silenceable** - An indicating appliance circuit (IAC) which remains active after initiation, independent of the alarm silence features.

**One-Man Test** - Maintenance mode to test initiating and indicating circuits. Creating an alarm on the Initiating Device Circuit (IDC) under test causes both Indicating Appliance Circuit (IAC) to pulse out the zone number of the zone under test (i.e., three rings for zone 3). Creating a trouble or ground fault condition on the IDC under test causes both IACs to output a single long pulse.

**Password, Dialer** - 4727 (GSBS)

**Power Limited** - Wiring and equipment which conforms with and is installed to the National Electrical Code, article 760, power limited provisions.

**Retard** - The delay of waterflow signals to prevent false alarms due to fluctuations in water pressure.

**Silenceable** - An Indicating Appliance Circuit (IAC) which follows the action of the alarm silence switch.

**SPM** - Strokes Per Minute.

**Style B Supervision, IDC** - Circuit monitoring technique which signals a trouble condition upon an *open* condition or *ground fault* on an Initiating Device Circuit. All devices up to the location of an open fault can initiate an alarm.

**Style D Supervision, IDC** - Circuit monitoring technique which signals a trouble condition upon an *open* condition or *ground fault* on an Initiating Device Circuit. All devices can initiate an alarm in the event of an open fault. Similar to Class A IDC supervision.

**Style Y Supervision, IAC** - Circuit monitoring technique which signals a trouble condition upon an *open*, *short*, or *ground fault* condition on an Indicating Appliance Circuit. Similar to Class B IAC supervision.

**Style Z Supervision, IAC** - Circuit monitoring technique which signals a trouble condition upon an *open*, *short*, or *ground fault* condition on an Indicating Appliance Circuit. All appliances can operate in spite of an open fault. Similar to Class A IAC supervision.

**Supervisory Operation** - An IDC used to monitor the status of critical fire protection equipment.

**Temporal Pattern** - A 3 pulse signal meeting the requirements of NFPA Standard 72, section A-2-4.10(a), and ULC 527.

**Verification, Alarm** - After receipt of an alarm by a smoke detector, verified zones attempt to automatically reset the detector. Receipt of a second alarm within the 60 second confirmation period after the automatic detector reset period transmits the alarm to the panel.

**Waterflow Zone** - IDCs defined as waterflow zones do not permit alarm silence while the alarm is active.

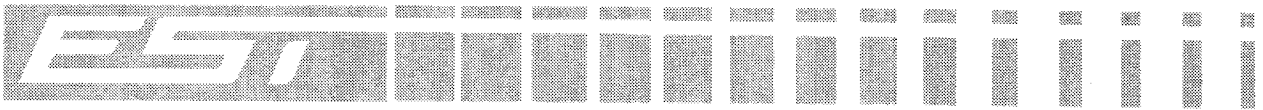

## 10.4 Appendix 4 - Standards Relevant to the Installation of this Product

**National Fire Protection Association  
(NFPA)**  
1 Batterymarch Park  
PO Box 9101  
Quincy, MA 02269-9101

NFPA 70, National Electric Code  
NFPA 72, National Fire Alarm Code

**Underwriters Laboratories Inc. (ULI)**  
333 Pfingsten Road  
Northbrook, IL 60062-2096

UL 38, Manually Actuated Signaling Boxes  
UL 217, Smoke Detectors, Single & Multiple  
Station  
UL 228 Door Closers/holders for Fire  
Protective Signaling Systems  
UL 268 Smoke Detectors for Fire Protective  
Signaling Systems  
UL 268A Smoke Detectors for Duct  
Applications  
UL 346 Waterflow Indicators for Fire  
Protective Signaling Systems  
UL 464 Audible Signaling Appliances  
UL 521 Heat Detectors for Fire Protective  
Signaling Systems  
UL 864, Standard for Control Units for Fire  
Protective Signaling Systems  
UL 1481, Power Supplies for Fire Protective  
Signaling Systems  
UL 1638 Visual Signaling Appliances  
UL 1971 Visual Signaling Appliances

**Underwriters Laboratories of Canada  
(ULC)**  
7 Crouse Road  
Scarborough, Ontario M1R 3A9

ULC S527, Standard for Control Units For Fire  
Alarm Systems  
ULC S524, Standard for the Installation of Fire  
Alarm Systems  
ULC S536, Standard for the Inspection and  
Testing of Fire Alarm Systems  
ULC S537, Standard for the Verification of  
Fire Alarm Systems

**Requirements of state and local building  
codes.**

**Requirements of the Authority Having  
Jurisdiction (AHJ).**



# 10.6 Appendix 6 - Panel Configuration and Programming Worksheet

Project Name: \_\_\_\_\_

IDC Programming Worksheet								
Panel Location ↕ IDC Programming	Zone							
	Base Panel IDC		1 <sup>st</sup> -2IDC Module		2 <sup>nd</sup> -2IDC Module		3 <sup>rd</sup> -2IDC Module	
	1	2	3	4	5	6	7	8
Zone Coverage Area								
Class B								
Class A								
ALARM, Non-verified Detector (Steady RED zone LED)								
ALARM, Verified Detector & Dry Contact Devices (* PAUSE * PAUSE *... RED zone LED)								
ALARM, Verified Detector ONLY (* * PAUSE * * PAUSE * *... RED zone LED)								
Normally-Open SUPERVISORY (Steady Amber zone LED)								
WATERFLOW (Steady Green zone LED)								
WATERFLOW with Retard (* PAUSE * PAUSE *... GREEN zone LED)								
Activate IAC #1 (IAC #1 Trouble LED ACTIVE)								
Activate IAC #2 (IAC #2 Trouble LED ACTIVE)								
Activate Remote Annunciator								



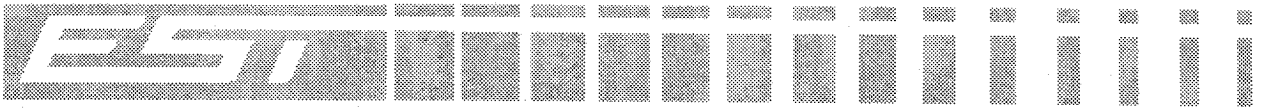

## Panel Configuration and Programming Worksheet

Page 2 of 3

Project Name: \_\_\_\_\_

### IAC Programming Worksheet

IAC Programming	IAC #1	IAC #2
Class B		
Class A		
Silenceable (Signal Trouble Circuit #2 LED ON AND Alarm Silenced LED = * PAUSE * PAUSE *...)		
Non-Silenceable (Signal Trouble Circuit #2 LED ON AND Alarm Silenced LED OFF)		
Continuous (Signal Trouble Circuit #2 LED ON Steady)		
120 SPM (Signal Trouble Circuit #2 LED 120 pulses/min)		
Temporal (Signal Trouble Circuit #2 LED Short-Short-Short-Long pulsing)		
Continuous California Rate (Signal Trouble Circuit #2 LED ON for 10 seconds, off for 5 seconds...)		
March Time California Rate (Signal Trouble Circuit #2 LED ON for 10 seconds @ 120 SPM, off for 5 seconds...)		

### Timer Configuration

<input type="checkbox"/> No Alarm Silence Inhibit	Zone Disabled LED OFF
<input type="checkbox"/> 1 Minute Alarm Silence Inhibit	Zone Disabled LED = * PAUSE * PAUSE *...
<input type="checkbox"/> 2 Minute Alarm Silence Inhibit	Zone Disabled LED = ** PAUSE ** PAUSE **...
<input type="checkbox"/> 3 Minute Alarm Silence Inhibit	Zone Disabled LED = *** PAUSE *** PAUSE ***...
<input type="checkbox"/> No Automatic Silence	Alarm Silenced LED OFF
<input type="checkbox"/> 10 Minute Automatic Silence	Alarm Silenced LED = * PAUSE * PAUSE *...
<input type="checkbox"/> 20 Minute Automatic Silence	Alarm Silenced LED = ** PAUSE ** PAUSE **...
<input type="checkbox"/> 30 Minute Automatic Silence	Alarm Silenced LED = *** PAUSE *** PAUSE ***...

### Auxiliary Power Reset Configuration

<input type="checkbox"/> Remains energized during Reset	Alarm Silenced LED OFF
<input type="checkbox"/> De-energize on Reset (alarm, verification, & test modes)	Alarm Silenced LED = * PAUSE * PAUSE *...

### Option Modules

<input type="checkbox"/> 2IDC Two Zone IDC Module (P/N 240456)
<input type="checkbox"/> RCT-1 Relay/City-Tie Module (P/N 240511)
<input type="checkbox"/> ADMM Annunciator Driver Master Module (P/N 240460)
<input type="checkbox"/> DL1 Dialer Module (P/N 240508)
<input type="checkbox"/> ADSM Annunciator Driver Slave Module (P/N 240462)

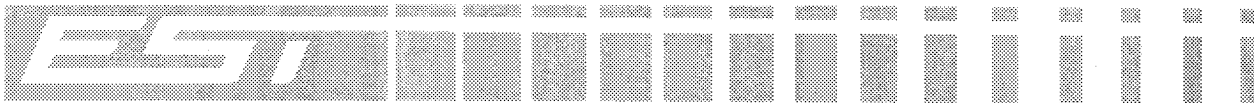

# Panel Configuration and Programming Worksheet

Project Name: \_\_\_\_\_

Description	Quantity		Supervisory (mA)	Total Supervisory (mA)	Alarm	Total Alarm
Base Panel	1	x	55	55	100	100
2 Zone input module		x	16		45	
Relay Modules		x	16		76	
Style D IDC Converter			0	0	40	
Dialer		x	12		25	
Annunciator Master		x	10		100	
Remote Trouble Unit		x	10		10	
Auxiliary Power (mA)						
Number of Detectors			0.050			
Signal Load (mA)						
			TOTAL	(A)		(B)
Battery Calculation						
Supervisory Hours		(C)				
Alarm Minutes		(D)				

$$\text{Battery Capacity (A.H.)} = \frac{(1.11 \times A \times C) + (0.033 \times B \times D)}{1000}$$

NOTE: Battery capacity of panel can be extended to 10 AH using the BC-2 Battery Cabinet

DL1 Dialer Module Worksheet	
Primary Phone # _____	Primary ID# _____
Secondary Phone # _____	Secondary ID# _____
Number of Retries _____	Retry Interval _____ Seconds
AC Power Failure Delay _____ Hours	

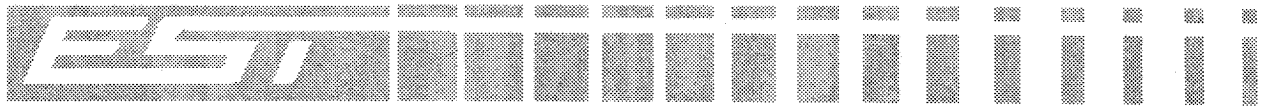

## 10.7 Appendix 7 - EST Offices

### EST Sales Offices, United States

#### Eastern Region

Farmington, CT  
(203) 699-3000

Millford, CT  
(203) 876-1234

Norwalk, CT  
(203) 847-1115

Boston, MA  
(617) 762-9115

Philadelphia, PA  
(Cherry Hill, NJ)  
(609) 482-5300

#### Mid-Atlantic Region

Lorton, VA  
(703) 550-7815

Washington DC/Baltimore, MD  
(Columbia, MD)  
(410) 312-1478  
(800) 829-6892

#### Mid-Western Region

Detroit, MI  
(313) 458-7777

Downers Grove, IL  
(708) 515-1900

Oak Brook Terrace, IL  
(708) 916-7770

Omaha, NE  
(402) 333-2611

#### Southern Region

Atlanta, GA  
(404) 451-0362

Boca Raton, FL  
(407) 367-0283

Miami, FL  
(305) 592-0510

Sarasota, FL  
(813) 756-3278

#### South Western Region

Dallas, TX  
(214) 233-8998

Houston, TX  
(713) 688-3175

#### Western Region

Los Angeles, CA  
(City of Industry)  
(818) 912-1399

Sacramento, CA  
(916) 737-2176

San Francisco, CA  
(Pleasanton, CA)  
(510) 463-1788

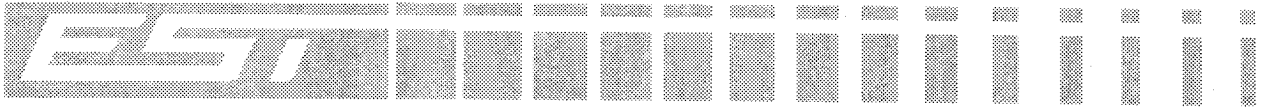

## EST Canadian Sales Offices/Bureaux De Venite

Burlington, ON  
(905) 632-6575

Calgary, AB  
(403) 253-9236

Dartmouth, NS  
(902) 468-9500

Edmonton, AB  
(403) 452-6411

Kitchener, ON  
(519) 746-4667

London, ON  
(519) 451-1522

Moncton, NB  
(506) 853-3060

Montreal, Quebec  
(514) 321-9961

Ottawa, ON  
(613) 820-3500

Quebec, QC  
(418) 681-0534

Regina, SK  
(306) 543-8688

Sudbury, ON  
(705) 560-4626

Toronto, ON  
(905) 678-7650

Vancouver, BC  
(604) 420-4113

Victoria, BC  
(604) 475-1076

Winnipeg, MB  
(204) 775-8281

INTERNATIONAL  
(905) 270-1711

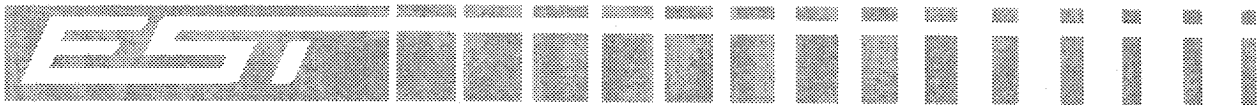

## EST Field Service Directory, Canada

Abitibi, QC  
(800) 361-2452

Antigonish, NS  
(902) 468-2280

Baie Comeau, QC  
(418) 589-4295  
(800) 463-6523

Barrie, ON  
(705) 722-3977

Belleville, ON  
(800) 668-7927

Brandon, MB  
(800) 665-1399

Burlington, ON  
(905) 632-6579

Calgary, AB  
(403) 252-5121

Comerbrook, NF  
(709) 639-7958

Dartmouth, NS  
(902) 468-2280

Edmonton, AB  
(403) 452-6609

Fredericton, NB  
(506) 452-8986

Kelowna, BC  
(604) 860-3991

Kingston, ON  
(800) 668-7927

London, ON  
(519) 451-1522

Moncton, NB  
(506) 853-3060

Montreal, QC  
(514) 321-9961

New Castle, NB  
(506) 852-3060

North Bay, ON  
(800) 461-5914

Oshawa, ON  
(800) 668-7927

Ottawa, ON  
(613) 820-3500

Peterborough, ON  
(800) 668-7927

Quebec City, QC  
(418) 681-0534  
(800) 463-6523

Regina, SK  
(306) 352-4652

Rimouski, QC  
(418) 722-9719  
(800) 463-6523

Saint John, NB  
(506) 633-7036

Saguenay/Lac St-Jean, QC  
(418) 545-3714  
(800) 463-6523

Sarnia, ON  
(519) 451-1522

Saskatoon, SK  
(306) 373-5722

Sault St. Marie, ON  
(800) 361-2452

St. Catherines, ON  
(800) 263-5139

St. John's, NF  
(709) 753-6674

Sudbury, ON  
(705) 560-4626

Sydney, NS  
(902) 468-2280

Timmins, ON  
(800) 461-5914

Thunder Bay, ON  
(807) 345-3231

Toronto (East)  
(905) 243-5198

Toronto (West)  
(905) 678-7606

Trois Rivières, QC  
(800) 361-2452

Vancouver, BC  
(604) 420-4436

Victoria, BC  
(604) 475-1076

Victoriaville, QC  
(800) 361-2452

Windsor, ON  
(519) 974-9080

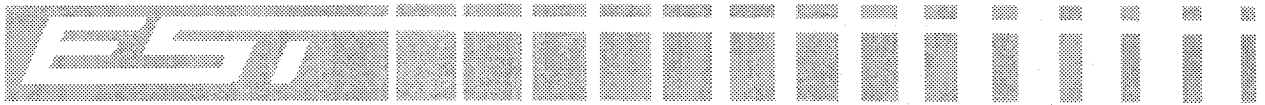

## 10.8 Appendix 8 - EST Catalog-to-P/N Cross Reference

EST Reorder Catalog Number	Description	Assembly Part Number	PC Board Part Number
EST1-2Z3	Two Zone, 120 VAC Panel w/3 Expansion Spaces, Gray Enclosure	46199-1055	
EST1-2Z3R	Two Zone, 120 VAC Panel w/3 Expansion Spaces, Red Enclosure	46199-1056	
EST1-2Z3-220	Two Zone, 220 VAC Panel w/3 Expansion Spaces, Gray Enclosure,	46199-1057	
EST1-2Z6	Two Zone, 120 VAC Panel w/6 Expansion Spaces, Gray Enclosure	46199-1058	
EST1-2Z6R	Two Zone, 120 VAC Panel w/6 Expansion Spaces, Red Enclosure	46199-1059	
EST1-2Z6-220	Two Zone, 220 VAC Panel w/6 Expansion Spaces, Gray Enclosure	46199-1060	
BC-2	Battery Cabinet, Gray	46035-2178	
BC-2R	Battery Cabinet, Red	46035-2179	
2IDC	Two Zone Initiating Device Circuit Module	240456	46212-1101
BPAC	Base Panel Class A (Style D/Z) Converter	46199-1071	46212-1104
IDCA	Two Zone IDC Module Class A (Style D) Adapter	46199-1073	46212-1105
RCT	Relay/City-Tie Module	240458	46212-1106
RCT-1	Relay/City-Tie Module	240511	140336
ADMM	Annunciator Driver Master	240460	140279
ADSM	Annunciator Driver Slave	240462	140284
DL1	Dialer Module	240508	140318, 140319
46199-1037	EST1-2Z3 Controller Assembly	46199-1037	46212-1102, 46212-1103
46199-1033	EST1-2Z3-220 Controller Assembly	46199-1033	46212-1102, 46212-1111
46199-1038	EST1-2Z6 Controller Assembly	46199-1038	46212-1102, 46212-1103
46199-1034	EST1-2Z6-220 Controller Assembly	46199-1034	46212-1102, 46212-1111
12V6A5	12 V, 6.5 AH Battery (2 Required)	12V6A5	
6V8A	6 V, 8.0 AH Battery (4 Required)	6V8A	
EOL-P1	ULC Listed 4.7K $\Omega$ End-Of-Line Resistor Plate	EOL-P1	
46229-0107	ULI Listed 4.7K $\Omega$ End-Of-Line Resistor	46229-0107	
46071-0409	ULI Listed series supervisory resistor (1.1K $\Omega$ ) and ULI Listed EOL resistor (3.6K $\Omega$ )'	46071-0409	
RTU	Remote Trouble Unit	46199-1075	46212-1056
RTUC	Remote Trouble Unit (French/English)	46199-1085	46212-1056
4ZA	Remote Annunciator, 4 Zone	46199-1077	46212-1056
4ZAC	Remote Annunciator, 4 Zone (French/ English)	46199-1086	46212-1055
8ZA	Remote Annunciator, Zone	46199-1080	46212-1055
8ZAC	Remote Annunciator, Zone (French/ English)	46199-1088	46212-1055
RTU4ZA	Remote Annunciator, 4 Zone w/ Trouble Unit	46199-1079	46212-1056, 46212-1055
RTU4ZAC	Remote Annunciator, 4 Zone w/ Trouble Unit (Fr./Eng.)	46199-1087	46212-1056, 46212-1055
RTU8ZA	Remote Annunciator, Zone w/ Trouble Unit	46199-1082	46212-1056, 46212-1055
RTU8ZAC	Remote Annunciator, Zone w/ Trouble Unit (Fr./Eng.)	46199-1089	46212-1056, 46212-1055

## CONTROL PANEL DIMENSIONS

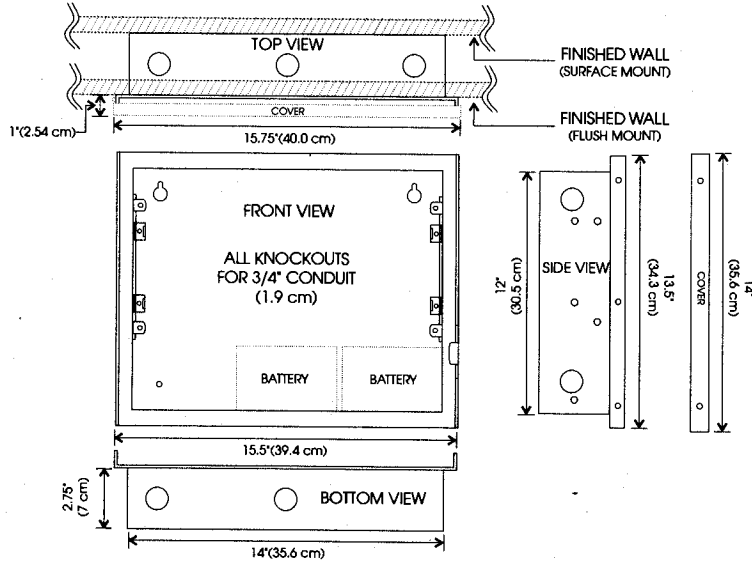

## CONTROL PANEL ASSEMBLY

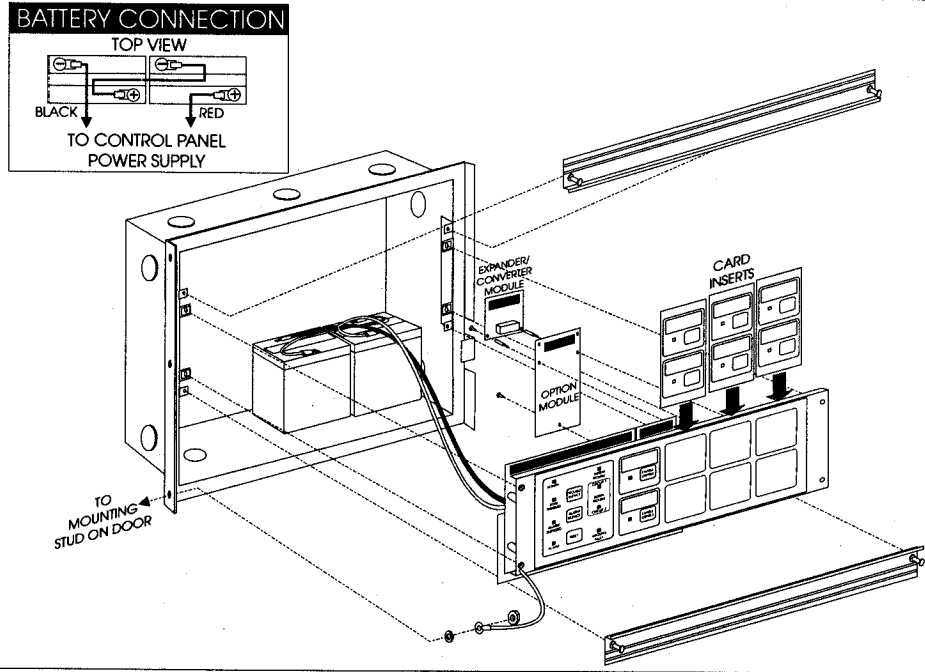

## MODULE AND WIRING PLACEMENT

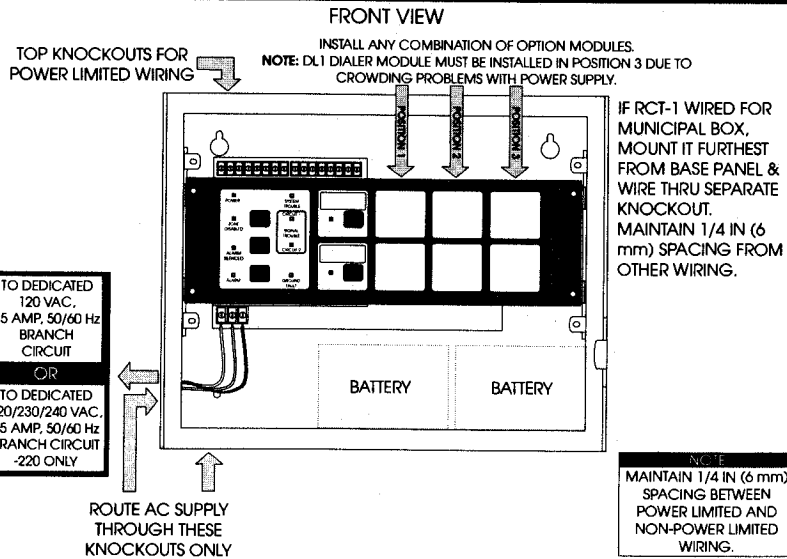

## CONTROL PANEL ASSEMBLY DETAIL

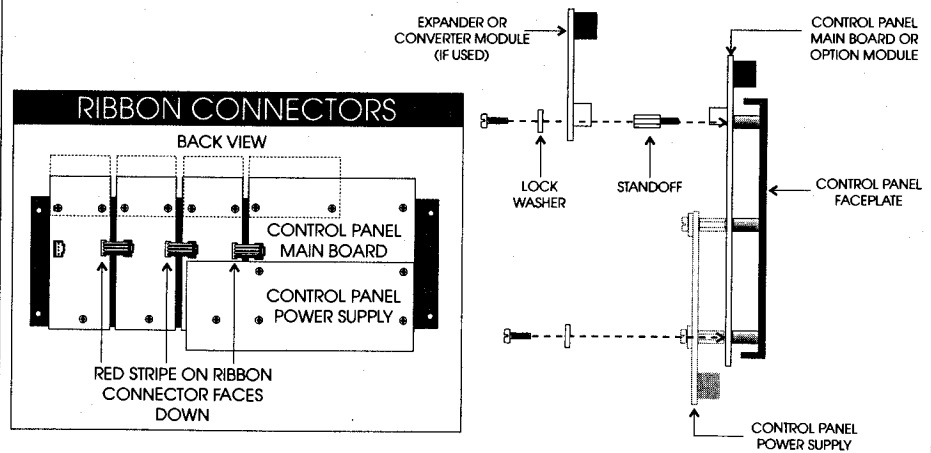

# CONTROL PANEL INSTALLATION 2

## CONTROL PANEL DIMENSIONS

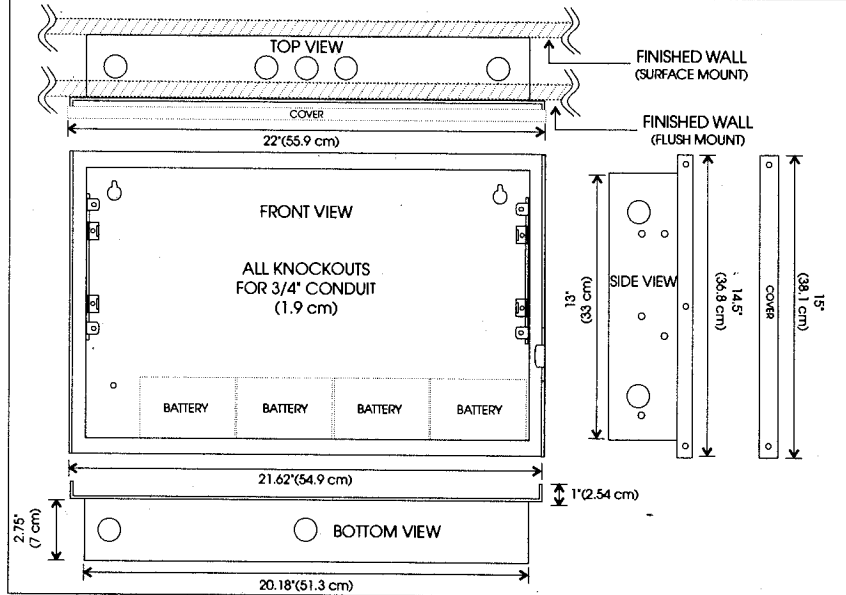

## CONTROL PANEL ASSEMBLY

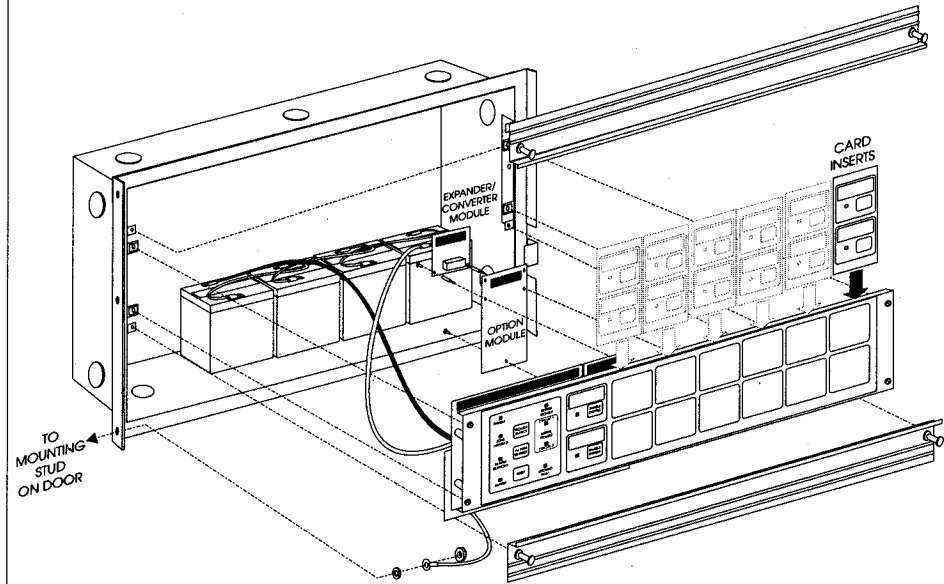

## MODULE AND WIRING PLACEMENT

INSTALL 1 TO 3 TWO ZONE INITIATING DEVICE CIRCUIT MODULES (2IDC) & ANY COMBINATION OF 3 OPTION MODULES: RELAY/CITY TIE (RCT-1), ANNUNCIATOR DRIVER (ADMM) MODULES OR DL1 DIALER MODULE. (NOTE: DIALER MODULE MUST BE INSTALLED IN POSITION 3, 4, 5, OR 6 DUE TO CROWDING PROBLEMS WITH POWER SUPPLY. IF RCT-1 WIRED FOR MUNICIPAL BOX, MOUNT IT FURTHEST FROM BASE PANEL & WIRE THRU SEPARATE KNOCKOUT. MAINTAIN 1/4 IN (6 mm) SPACING FROM OTHER WIRING.

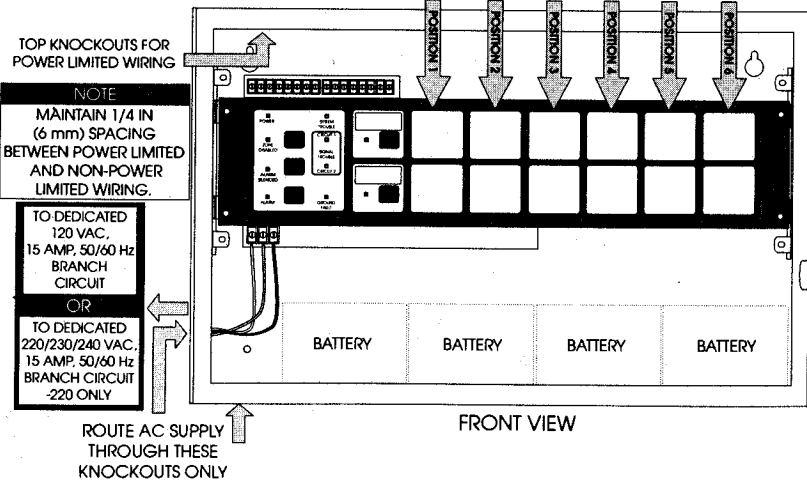

## CONTROL PANEL ASSEMBLY DETAIL

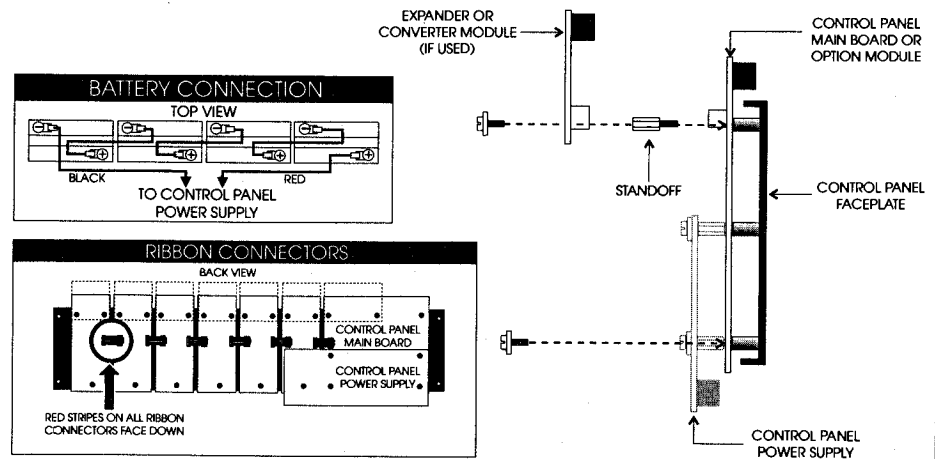



# CONTROL PANEL

**NOTES**

- ⚠ POWER LIMITED
- ⚠ SUPERVISED
- ⚠ SHOWN IN NORMAL CONDITION.
- ⚠ POWER LIMITED. (USE AUX. POWER OR LISTED FIRE PROTECTIVE SIGNAL TRANSFORMER.)

REFER TO INDICATING APPLIANCE CIRCUIT WIRING DETAILS  
MAX. OUTPUT BOTH CIRCUITS = 4.0 A.

REFER TO INITIATING DEVICE CIRCUIT WIRING DETAILS

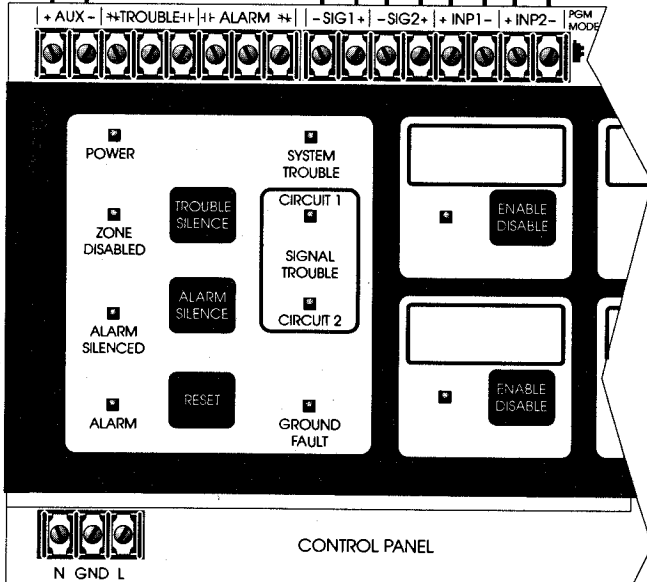
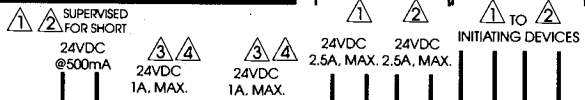

ROUTE POWER WIRING AWAY FROM ALL POWER LIMITED CIRCUITS

TO 120 VAC, 3.5A, 50/60HZ DEDICATED BRANCH CIRCUIT 15A. OR TO 220/230/240 VAC, 1.75A, 50/60HZ DEDICATED BRANCH CIRCUIT 15A.

**INDICATING APPLIANCE CIRCUIT MAXIMUM WIRING RUNS**

LOAD CURRENT	MAXIMUM STYLE Y (CLASS B) RUN TO EOL RESISTOR, MAXIMUM STYLE Z (CLASS A) LOOP WIRING DISTANCE.			
	#12 AWG FEET (METERS)	#14 AWG FEET (METERS)	#16 AWG FEET (METERS)	#18 AWG FEET (METERS)
0.10	10625 (3239)	6538 (1993)	4250 (1296)	2615 (797)
0.25	4250 (1296)	2615 (797)	1700 (518)	1046 (319)
0.50	2125 (648)	1308 (399)	850 (259)	523 (159)
0.75	1417 (432)	872 (266)	567 (173)	349 (106)
1.00	1063 (324)	654 (199)	425 (130)	262 (80)
2.00	531 (162)	327 (100)	213 (65)	131 (40)
2.50	425 (130)	262 (80)	170 (52)	105 (32)

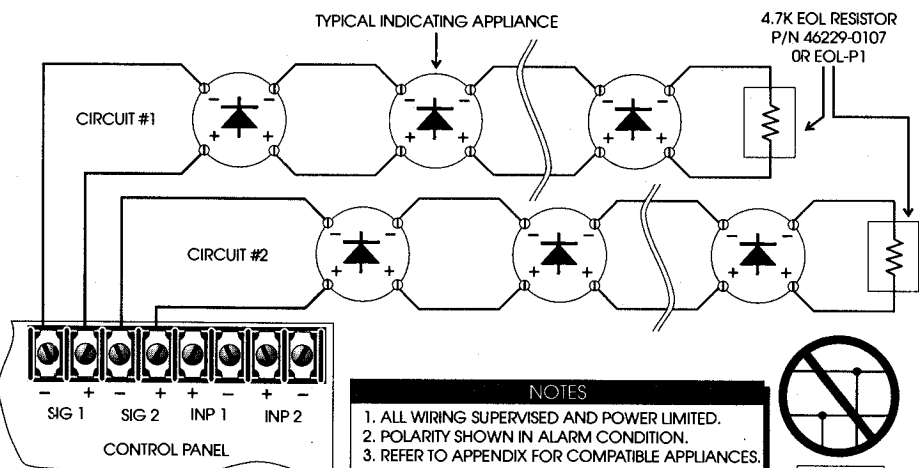

**NOTES**

1. ALL WIRING SUPERVISED AND POWER LIMITED.
2. POLARITY SHOWN IN ALARM CONDITION.
3. REFER TO APPENDIX FOR COMPATIBLE APPLIANCES.



NO T-TAPS PERMITTED

**STYLE Y (CLASS B) INDICATING APPLIANCE CIRCUIT WIRING**

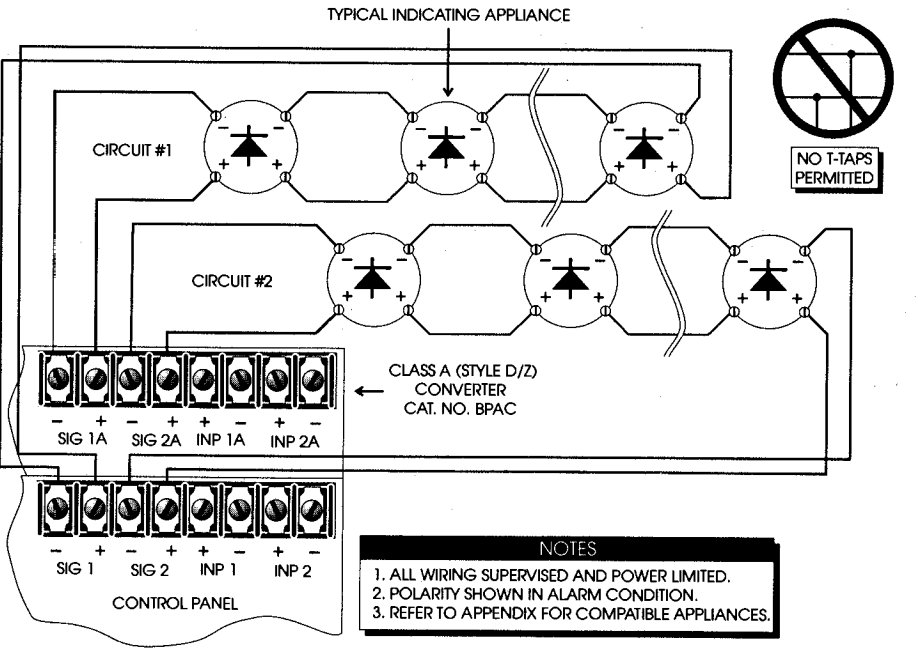

**NOTES**

1. ALL WIRING SUPERVISED AND POWER LIMITED.
2. POLARITY SHOWN IN ALARM CONDITION.
3. REFER TO APPENDIX FOR COMPATIBLE APPLIANCES.



NO T-TAPS PERMITTED

**STYLE Z (CLASS A) INDICATING APPLIANCE CIRCUIT WIRING**

# INITIATING DEVICE CIRCUIT WIRING

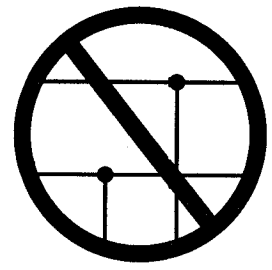
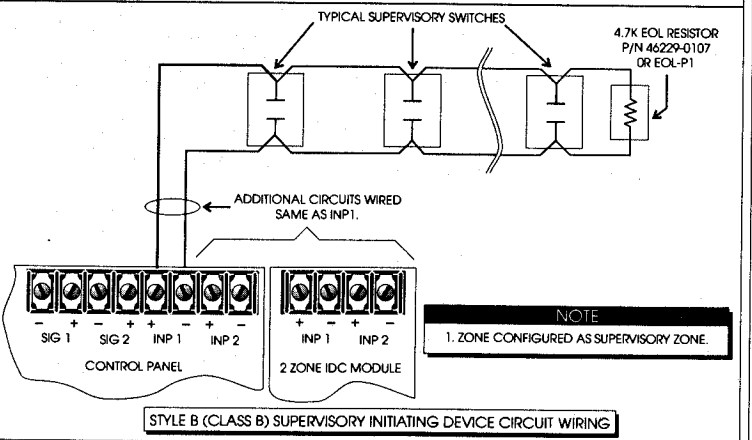
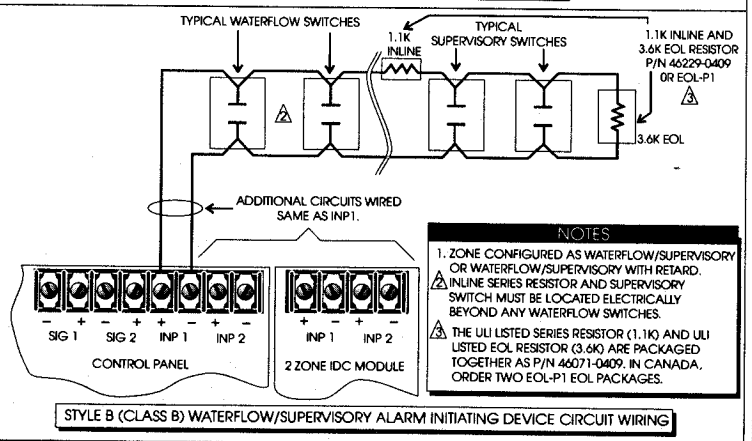
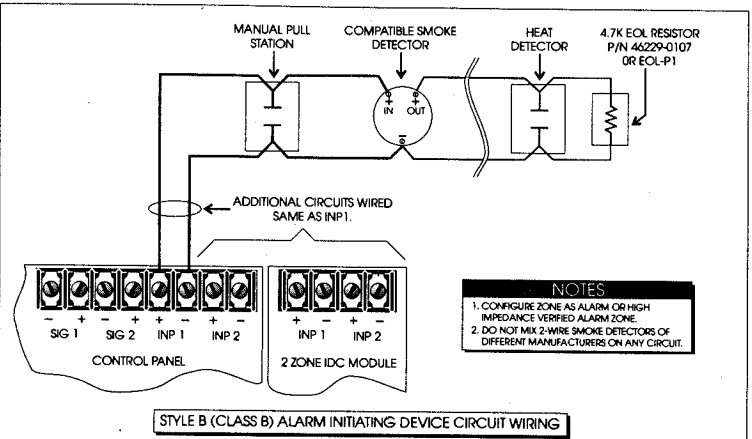

**NO T-TAPS PERMITTED**

- NOTES**
1. ALL WIRING SUPERVISED AND POWER LIMITED.
  2. MAXIMUM WIRE RESISTANCE SHOULD NOT EXCEED 50 OHMS PER CIRCUIT.
  3. NO T-TAPS PERMITTED ON ANY IDC CIRCUITS.
  4. REFER TO APPENDIX FOR COMPATIBLE DEVICES.
  5. 2-WIRE RELAY BASES ARE NOT SUPPORTED.
  6. SEE **CONTROL PANEL APPLICATIONS 2** DRAWING FOR 4-WIRE RELAY BASE CONFIGURATION.

**INITIATING DEVICE CIRCUIT MAXIMUM WIRING RUNS**

WIRE GAUGE	MAXIMUM WIRE RUN (TO EOL RESISTOR OR CLASS A LOOP LENGTH) FEET (METERS)
12	10000 (3049)
14	9600 (2927)
16	6250 (1905)
18	3800 (1159)

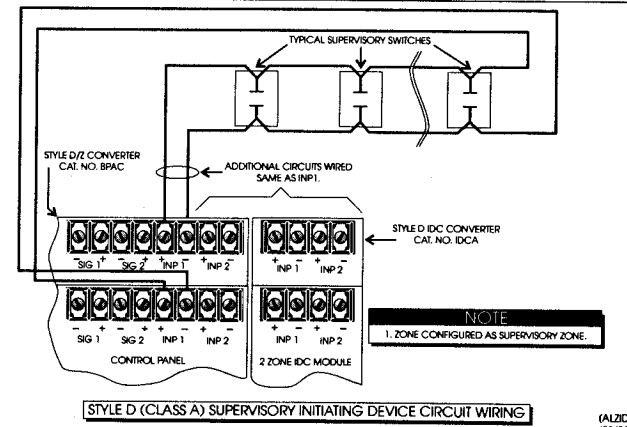
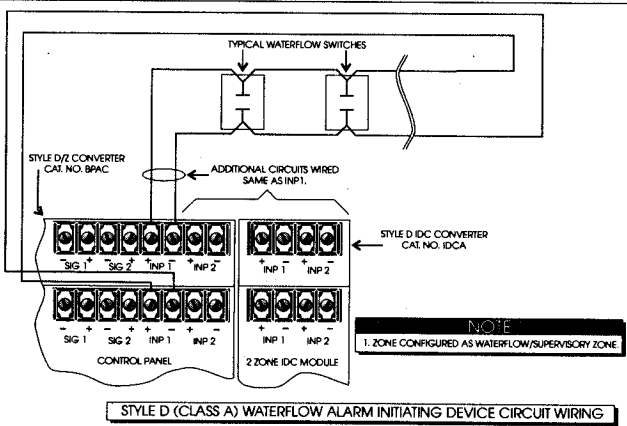
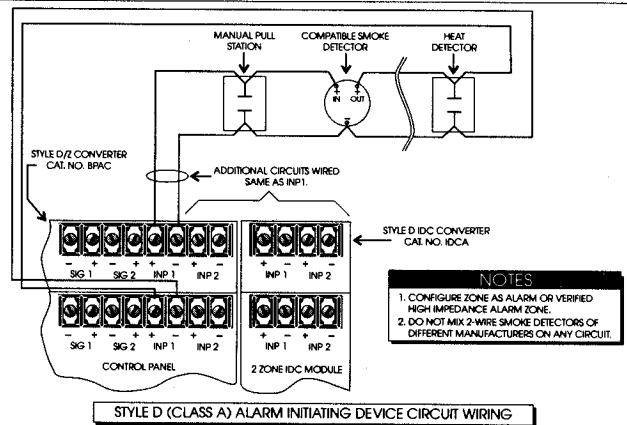

# RELAY / CITY-TIE MODULE

## SHUNT CONNECTION / DRY CONTACT

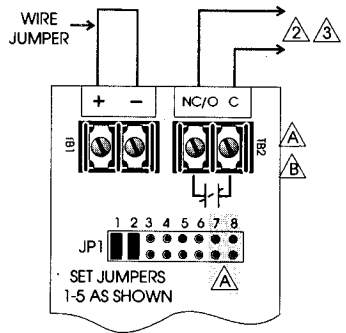

### NOTES

- CONTACTS RATED 24 VDC/VAC @ 1 A.
- THE SHUNT CONNECTION IS RECOGNIZED ONLY AS A SUPPLEMENTARY SIGNALING UNIT AS PART OF A LOCAL CONTROL UNIT AND IS NOT RECOGNIZED AS AN AUXILIARY CONTROL UNIT CONNECTION PER NFPA 72.
- CIRCUIT IS NOT SUPERVISED OR POWER LIMITED.

## LOCAL ENERGY MASTER BOX

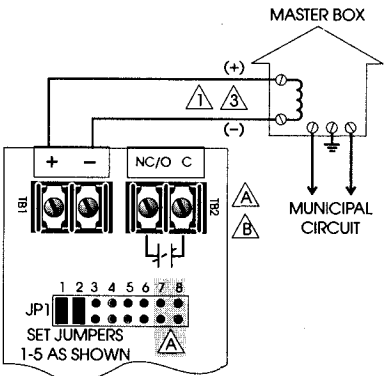

### NOTES

- 250 mA INTO A 14.5 OHM TRIP COIL. MAX. LOOP RESISTANCE= 25 OHMS.
- CIRCUIT IS SUPERVISED FOR OPENS.
- CIRCUIT NOT SUPERVISED FOR SHORTS AND IS NOT POWER LIMITED
- MAY BE USED SIMULTANEOUSLY WITH DRY CONTACT.

## REVERSE POLARITY

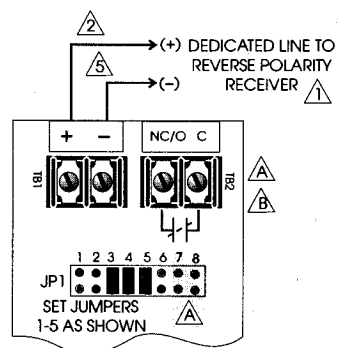

### NOTES

- POLARITY SHOWN IN NORMAL STATE.
- MAXIMUM LINE RESISTANCE 1500 OHMS.
- CURRENT RANGE IS 2.6 - 9.5 mA.
- COMPLIES WITH NEMA SB3-1969.
- POWER LIMITED.
- MAY BE USED SIMULTANEOUSLY WITH DRY CONTACT.

## NOTE B

JUMPER JP2 1-3 CONFIGURES THE MODULE TO OPERATE IN EITHER ALARM, TROUBLE, SUPERVISORY, OR RESET MODES- WHEN MODULE NOT DISABLED.

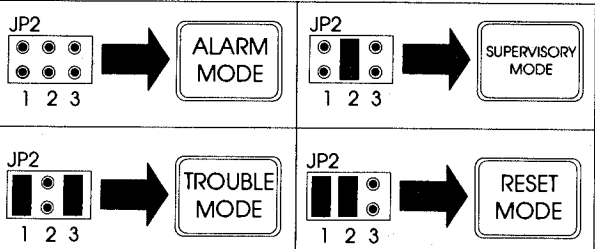

INCORRECT JUMPER SETTINGS WILL RESULT IN IMPROPER OPERATION

### CAUTION

REMOVE ALL POWER BEFORE CHANGING JUMPERS

## NOTE A

JUMPER JP1 7-8 DETERMINES CONTACT CONFIGURATION

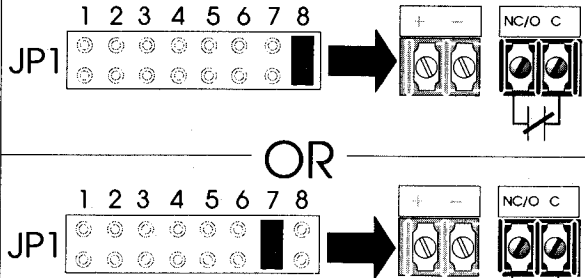

CONTACT OPERATES SIMULTANEOUSLY WITH REMOTE OUTPUT CONTACT SHOWN IN NORMAL STATE- WHEN CONFIGURED FOR TROUBLE OPERATION, RELAY IS ENERGIZED AND CONTACT STATE REVERSED.

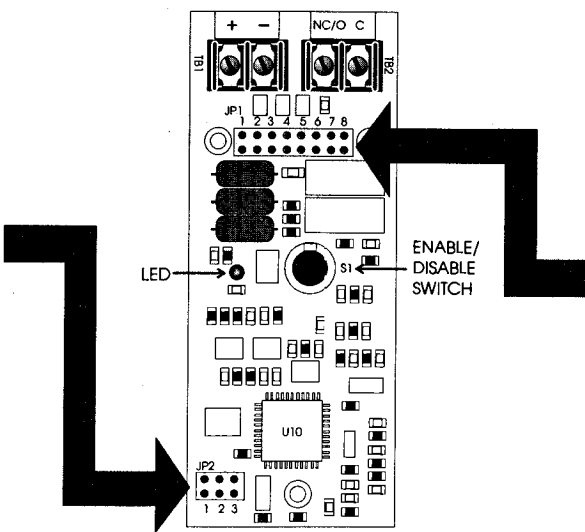

# DIALER MODULE

## INSTALLATION STEP 1

- A** INSTALL DIALER MODULE IN PANEL. SEE PANEL INSTALLATION DRAWING.
- B** INSTALL BUS INTERFACE BOARD ON BACK OF DIALER MODULE.
- C** CONNECT RIBBON CABLE FROM MAIN CONTROL PANEL OR ADJACENT MODULE

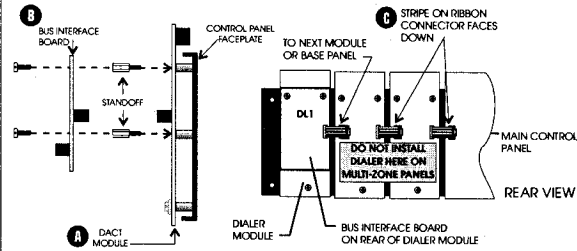

## INSTALLATION STEP 2

- A** CONNECT J1 AND J2 TO RJ31X OR RJ38X (CA31A OR CA38A IN CANADA) TELEPHONE JACKS INSTALLED BY AUTHORIZED TELEPHONE COMPANY REPRESENTATIVE. JACKS MUST BE INSTALLED WITHIN 5 FT. (1.5 M) OF PANEL. PROTECTIVE GROMMET SUPPLIED FOR ENCLOSURE KNOCKOUT.

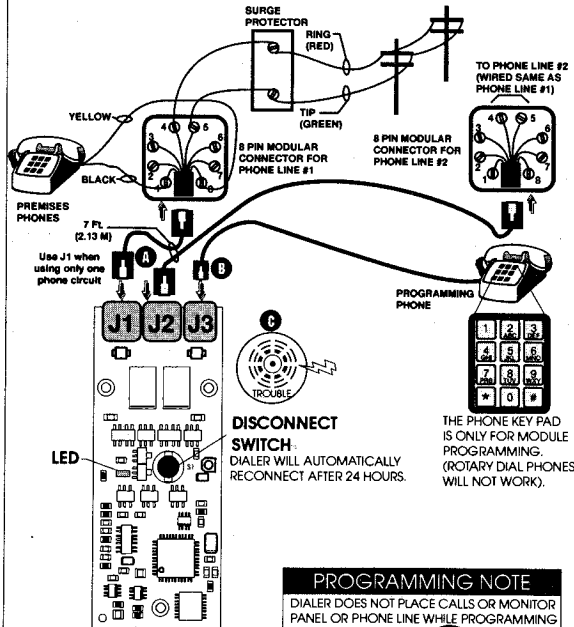

### PROGRAMMING NOTE

DIALER DOES NOT PLACE CALLS OR MONITOR PANEL OR PHONE LINE WHILE PROGRAMMING



CAUTION

## LED LEGEND

- = LED OFF
- ⚙️/⚙️ = SLOW FLASH
- ⚙️/⚙️/⚙️ = RAPID FLASH
- ⚙️ = ON STEADY
- ⚙️/⚙️/⚙️/⚙️ = 2-PHASE FLASH
- RED = LED COLOR

### PROGRAMMING STEP A - ENTER PROGRAMMING MODE

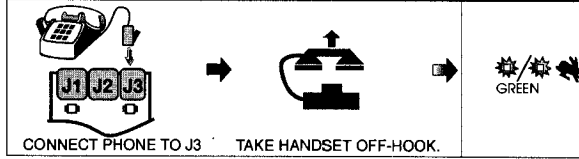

### PROGRAMMING STEP B - ENTER PASSWORD



### PROGRAMMING STEP C - ENTER DIALER DATA



#### PROGRAMMING ITEM 01 - PRIMARY SITE ID NUMBER



#### PROGRAMMING ITEM 02 - PRIMARY CMS PHONE NUMBER



#### PROGRAMMING ITEM 03 - SECONDARY SITE ID NUMBER



#### PROGRAMMING ITEM 04 - SECONDARY CMS PHONE NUMBER



#### PROGRAMMING ITEM 05 - 1 OR 2 PHONE LINE OPERATION



#### PROGRAMMING ITEM 06 - NUMBER OF CMS RETRY CALLS



#### PROGRAMMING ITEM 07 - RETRY INTERVAL



#### PROGRAMMING ITEM 08 - AC FAILURE DELAY



#### PROGRAMMING ITEM 09 - FIRST SUPERVISION CALL DELAY



#### PROGRAMMING ITEM 10 - 24 HR. TROUBLE RETRANSMISSION CHECK IN



#### PROGRAMMING ITEM 11 - ZONE/CODE ORDER



#### PROGRAMMING STEP D - EXIT PROGRAMMING MODE

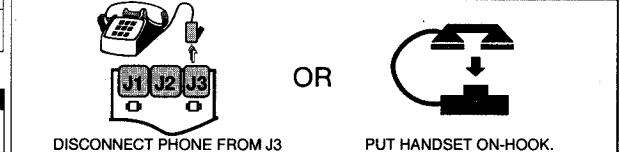

#### DEFAULT PROGRAM ITEM RESTORATION



#### PROGRAMMING ITEM VERIFICATION



### GENERAL NOTES

1. CONFIRMATION BEEP INDICATES PROGRAM ITEM ENTERED.
2. PHONE LINES MUST BE LOOP START ON A PUBLIC SWITCHED NETWORK. PBX, GROUND START, AND PARTY LINES ARE NOT ACCEPTABLE.
3. PASSWORD = 4727 (GSBS).
4. AFTER INITIAL PROGRAMMING, DIALER NOTIFIES CENTRAL MONITORING STATION OF TROUBLE BEFORE PROGRAMMING CAN PROCEED.
5. TWO PHONE LINES ARE REQUIRED TO COMPLY WITH NFPA 72.
6. DIALER WILL AUTOMATICALLY SWITCH TO PULSE DIALING AFTER THREE CONSECUTIVE FAILURES USING TONE MODE. DIALER WILL SWITCH BACK TO TONE DIALING AFTER FAILING TO CONNECT USING PULSE MODE, OR UPON RE-PROGRAMMING.

### DIALER LED OPERATION

⚙️/⚙️ = DIALING  
GREEN

⚙️ = FIRE ALARM SENT & ACKNOWLEDGED  
RED

⚙️/⚙️/⚙️ = SUPERVISORY ALARM SENT & ACKNOWLEDGED  
AMBER

⚙️ = SUPERVISORY RESTORE SENT & ACKNOWLEDGED  
AMBER

⚙️/⚙️ = MODULE / PHONE TROUBLE  
AMBER

⚙️/⚙️/⚙️/⚙️ = MODULE DISABLED  
AMBER

## MODULE INSTALLATION

- A** INSTALL DIALER MODULE IN PANEL. NOTE MODULE AND WIRING PLACEMENT DIAGRAM ON PAGE 2.
- B** INSTALL BUS INTERFACE BOARD ON BACK OF DIALER MODULE.
- CAUTION:** STANDOFFS MUST LINE UP WITH HOLES IN BUS INTERFACE BOARD TO PROPERLY MATE THE CONNECTORS.
- C** CONNECT RIBBON CABLE TO MAIN CONTROL PANEL OR ADJACENT MODULE.

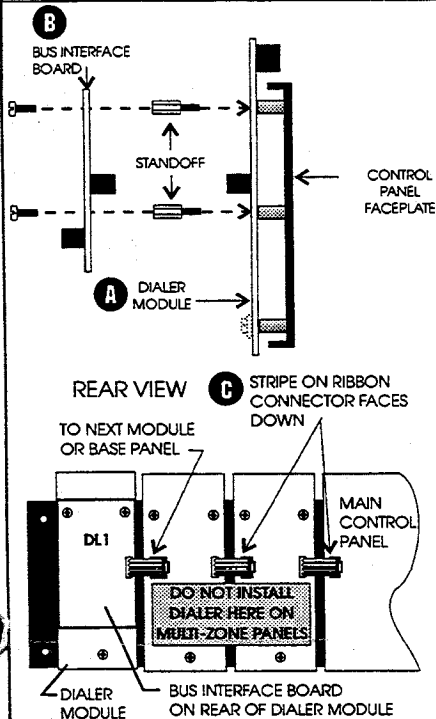

### CAUTION

1. Remove AC and battery power before installing or removing option modules.
2. The panel **MUST** be reprogrammed whenever permanently *adding* (or *removing*) option modules to (from) the system. Replacing a module with another module of the same type does **NOT** require reprogramming.

## SPECIFICATIONS

Expansion Space	1 space
Phone Line (two phone lines required to comply with NFPA 72)	One / two loop start lines on public switched telephone network, pulse or DTMF dialing. Party and PBX lines are not acceptable.
Wall Connector	Standard RJ31X phone jack.
Line Supervision	Trouble when line voltage <10V & line current <5 mA.
Communications Protocols	SIA pulse format P3, 20 PPS, 3/2 or 4/2, double round, 1400 Hz handshake, 1900 Hz carrier
CMS Telephone Numbers	Two, 24 digit numbers
FCC Registration Number	4Z2USA-22549-AL-E
Dialing Retrys	5 to 10
AC Power Failure Delay	0 to 18 Hours
Clock Accuracy	Within one hour/year
Compliance	Communications Canada CS-03 FCC / CFR 47 Parts 15 & 68 NFPA 72 UL 864 ULC S527-M87
Programming Phone	Any Tone Dial Phone with RJ11 plug

## MODULE WIRING

- A** CONNECT J1 AND J2 TO RJ31X OR RJ38X (CA31A OR CA38A IN CANADA) TELEPHONE JACKS INSTALLED BY AUTHORIZED TELEPHONE COMPANY REPRESENTATIVE. JACKS MUST BE INSTALLED WITHIN 5 FT. (1.5 M) OF PANEL. PROTECTIVE GROMMET SUPPLIED FOR ENCLOSURE KNOCKOUT.
- B** REFER TO MANUAL FOR PROGRAMMING.
- NOTE:** IF PHONE NUMBERS HAVE BEEN PREVIOUSLY ENTERED INTO DIALER, DIALER WILL NOTIFY MONITORING STATION BEFORE PROGRAMMING CAN PROCEED.

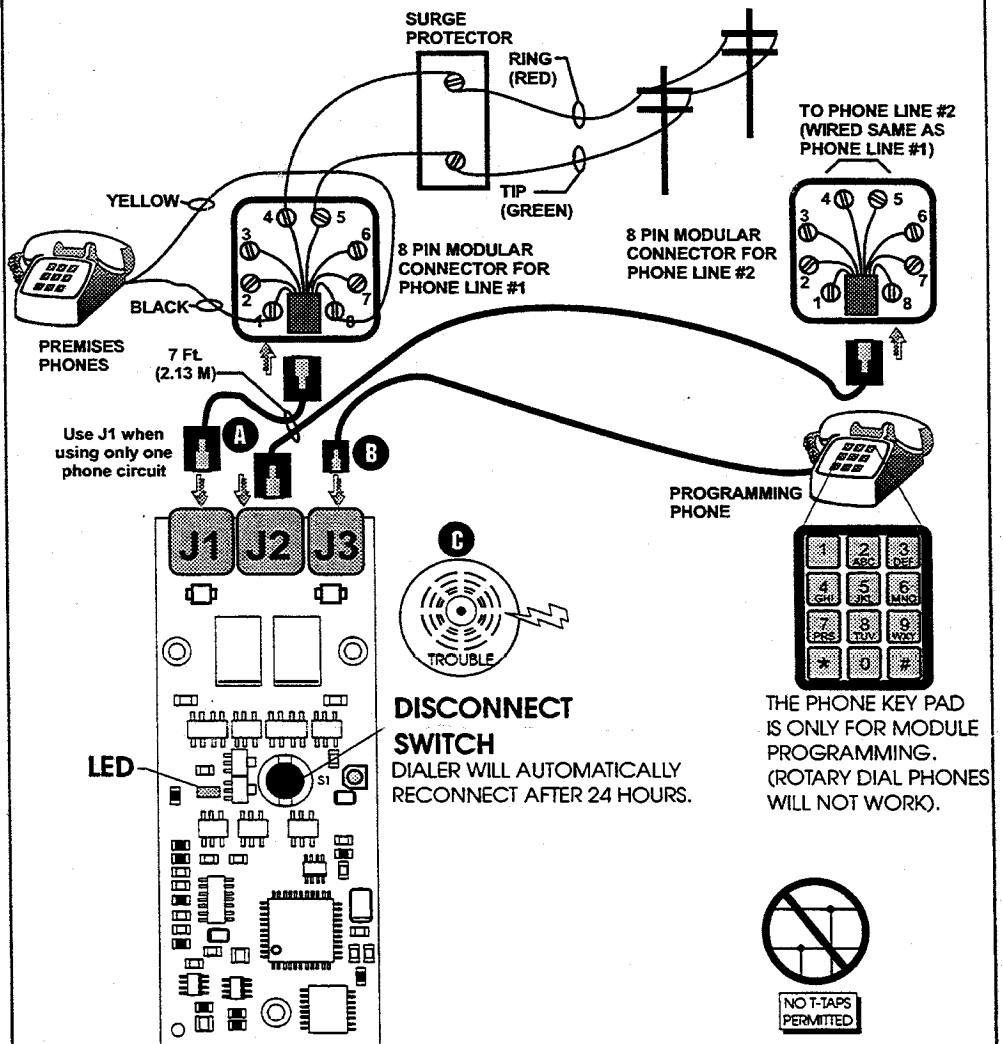

COMPONENTS IN THIS SYSTEM ARE STATIC SENSITIVE. DISCHARGE STATIC BUILDUP ON YOUR BODY BEFORE HANDLING.

Voir manuel d'installation expédié avec le panneau.  
Vea el manual de instalación expedido con el panel.

INSTALLATION SHEET:

### DIALER MODULE

INSTALLATION SHEET P/N: 387121

FILE NAME: 387121.CDR

REVISION LEVEL: 1.2

APPROVED BY: D.B.

DATE: 11/06/96

CREATED BY: R<sup>2</sup>W

# MODULE AND WIRING PLACEMENT

INSTALL 1 TO 3 TWO ZONE INITIATING DEVICE CIRCUIT MODULES (2IDC) & ANY COMBINATION OF OPTION MODULES: RELAY/CITY TIE (RCT-1), ANNUNCIATOR DRIVER (ADMM) MODULES OR DIALER MODULE. (NOTE: DIALER MODULE MUST BE INSTALLED IN POSITION 3 OR HIGHER DUE TO CROWDING PROBLEMS WITH POWER SUPPLY. IF RCT-1 WIRED FOR MUNICIPAL BOX, MOUNT IT FURTHEST FROM BASE PANEL & WIRE THRU SEPARATE KNOCKOUT. MAINTAIN 1/4 IN (6 mm) SPACING FROM OTHER WIRING.

TOP KNOCKOUTS FOR POWER LIMITED WIRING

**NOTE**  
 MAINTAIN 1/4 IN (6 mm) SPACING BETWEEN POWER LIMITED AND NON-POWER LIMITED WIRING.

TO DEDICATED 120 VAC, 15 AMP, 50/60 Hz BRANCH CIRCUIT

OR  
 TO DEDICATED 220/230/240 VAC, 15 AMP, 50/60 Hz BRANCH CIRCUIT -220 ONLY

ROUTE AC SUPPLY THROUGH THESE KNOCKOUTS ONLY

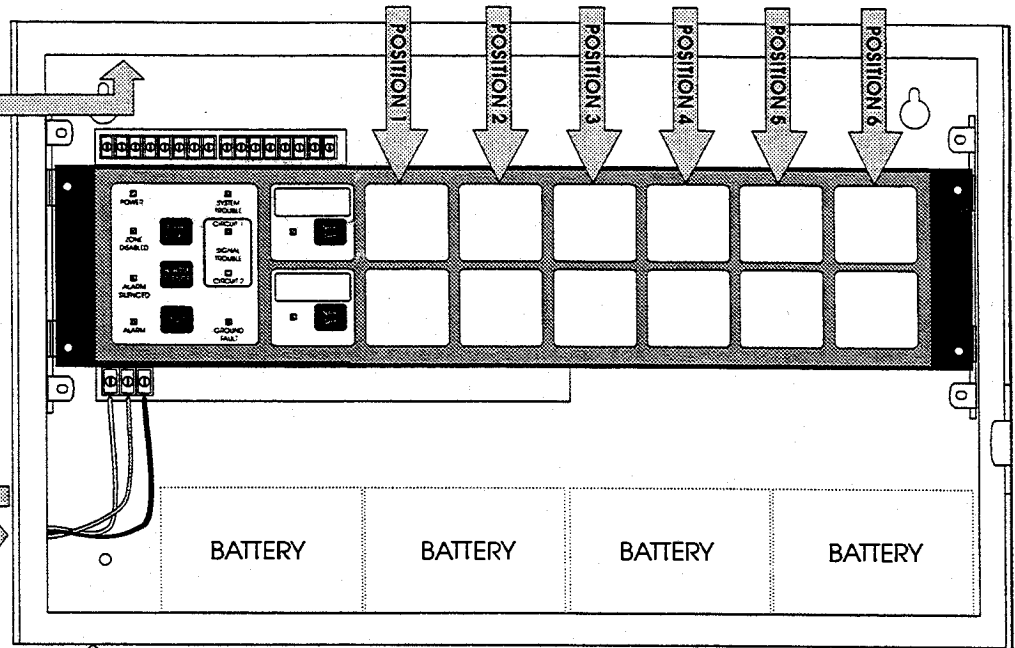

FRONT VIEW

## NOTES

### FCC Information

1. The dialer complies with Part 68 of the FCC rules. The Dialer's FCC registration number and Ringer Equivalence Number (REN) are on the back of the dialer. This information must be provided to the telephone company if requested.
2. An FCC compliant telephone cord and modular plug cord is supplied with the dialer. The dialer is designed to be connected to the telephone network using the supplied cord and an RJ31X or RJ38X jack, which must also comply with FCC Part 68 rules.
3. The REN is used to determine the quantity of devices which may be connected to the telephone line. Excessive RENs on the telephone line may result in the devices not ringing in response to an incoming call. In most, but not all areas, the sum of RENs should not exceed five (5). To be certain of the number of devices that may be connected to a line as determined by the total RENs, contact the local telephone company.
4. If the dialer causes harm to the telephone network, the telephone company will notify you in advance that temporary discontinuance of service may be required. If advance notice is not practical, the telephone company will notify you as soon as possible. You will also be advised of your right to file a complaint with the FCC, if you believe it is necessary.
5. The telephone company may make changes in its facilities, equipment, operations, or procedures that could affect the operation of the dialer. If this happens, the telephone company will provide advance notice in order for you to make necessary modifications to maintain uninterrupted service.
6. If trouble is experienced with the dialer, for repair or warranty information, contact Edwards Systems Technology, 6411 Parkland Drive, Sarasota, Florida USA 34243 Telephone: 1-800-655-4497. If the dialer is causing harm to the telephone network, the telephone company may request you disconnect the dialer until the problem is resolved.
7. No repairs may be performed on the dialer by the user.
8. The dialer can not be used on public coin phones or party line service provided by the telephone company.

### Canada DOC Information

**NOTICE:** The Canadian Department of Communications label identifies certified equipment. This certification means that the equipment meets certain telecommunications network protective, operational, and safety requirements. The Department does not guarantee the equipment will operate to the user's satisfaction.

Before installing this equipment, users should ensure that it is permissible to be connected to the facilities of the local telecommunications company. The equipment must also be installed using an acceptable method of connection. The customer should be aware that compliance with the above conditions may not prevent degradation of service in some situations.

Repairs to certified equipment should be made by an authorized Canadian maintenance facility designated by the supplier. Any repairs or alterations made by the user to this equipment, or equipment malfunctions, may give the telecommunications company cause to request the user to disconnect the equipment.

Users should ensure for their own protection that the electrical ground connections of the power utility, telephone lines, and internal metallic water pipe system, if present, are connected together. This precaution may be particularly important in rural areas.

**Caution:** Users should not attempt to make connections themselves, but should contact the appropriate electric inspection authority, or electrician, as appropriate.

**NOTICE:** The Load Number (LN) assigned to each terminal device denotes the percentage of the total load to be connected to a telephone loop which is used by the device to prevent overloading. The termination on a loop may consist of any combination of devices subject only to the requirements that the sum of the Load Numbers of all devices does not exceed 100.

# REMOTE ANNUNCIATORS

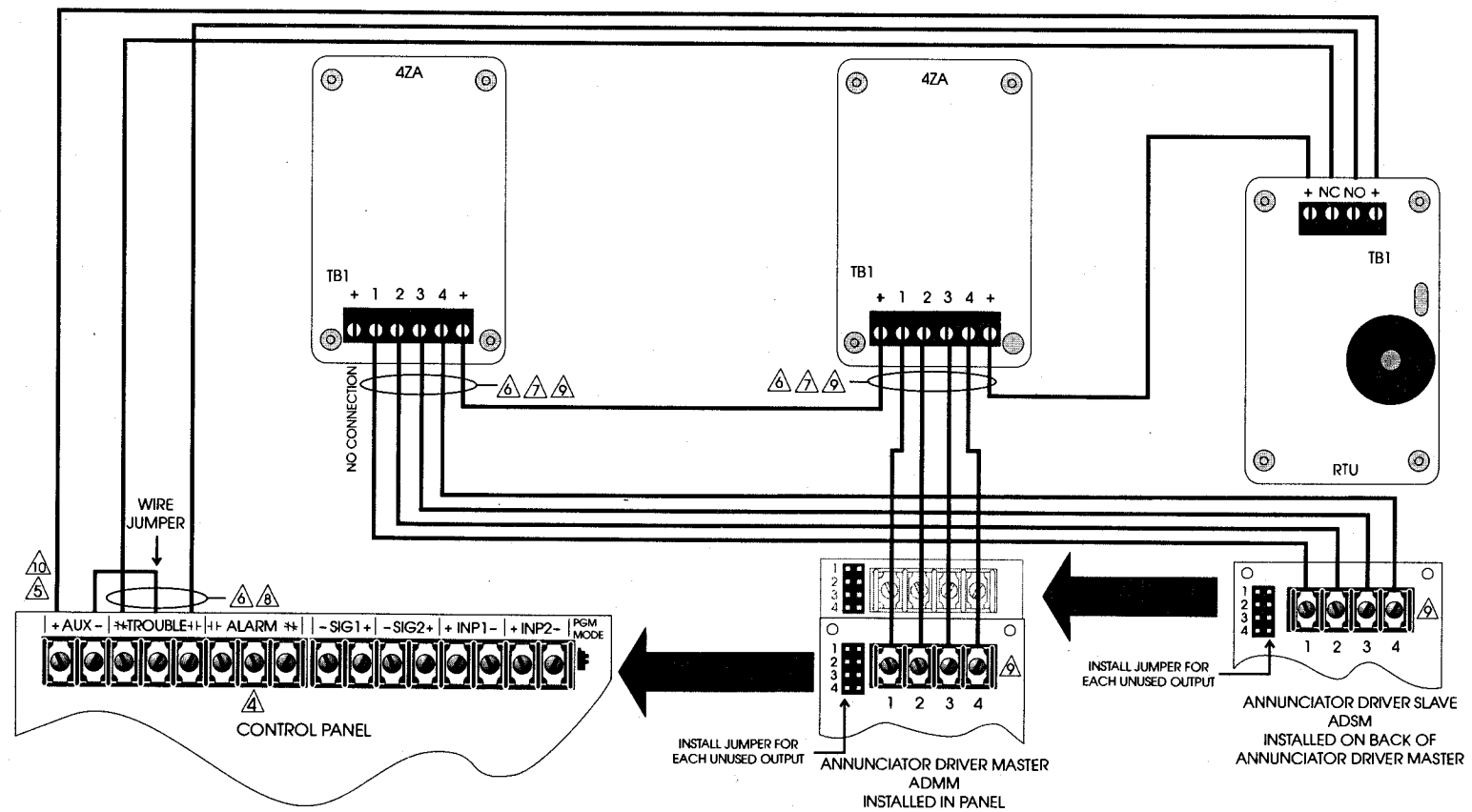

- ### NOTES
- IF **NOT** USING 4-WIRE SMOKE DETECTOR, CONFIGURE AUXILIARY POWER AS NON-RESETTABLE.
  - REFER TO BATTERY CALCULATION SECTION FOR POWER REQUIREMENTS.
  - ALL WIRING POWER LIMITED.
    - ⚠ CONTACTS SHOWN IN NORMAL CONDITION.
    - ⚠ POSITIVE ANNUNCIATOR POWER WIRING:  
18 AWG MIN.=7,500' (2,300 M) MAX.  
22 AWG MIN.=3,000' (900 M) MAX.
    - ⚠ LED ANNUNCIATOR WIRING:  
22 AWG MIN.=7,500' (2,300 M) MAX.
    - ⚠ SUPERVISED FOR OPENS AND GROUND FAULTS.
    - ⚠ NOT SUPERVISED.
    - ⚠ 24VDC NOMINAL @ 15mA DC MAX. PER CIRCUIT.
    - ⚠ 24VDC NOMINAL @ 500mA DC MAX

### IDC TO ANNUNCIATOR DRIVER CORRELATION

ACTIVE IDC ZONE	ACTIVATED ANNUNCIATOR DRIVER MASTER (ADMM) OUTPUT	ACTIVATED ANNUNCIATOR DRIVER SLAVE (ADSM) OUTPUT
BASE PANEL IDC ZONE #1	1	N/A
BASE PANEL IDC ZONE #2	2	N/A
1st IDC MODULE, ZONE #1	3	N/A
1st IDC MODULE, ZONE #2	4	N/A
2nd IDC MODULE, ZONE #1	N/A	1
2nd IDC MODULE, ZONE #2	N/A	2
3rd IDC MODULE, ZONE #1	N/A	3
3rd IDC MODULE, ZONE #2	N/A	4

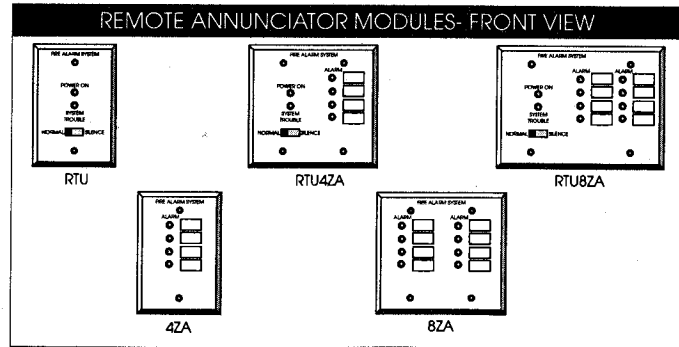

### ANNUNCIATOR COMPONENT SELECTION GUIDE

MODE	PANEL OPTION MODULE(S)	ANNUNCIATOR HARDWARE	ANNUNCIATOR MOUNTING
TROUBLE ONLY	NONE	RTU	1 GANG BOX
TROUBLE & 4 ALARM ZONES	ANNUNCIATOR DRIVER MASTER	RTU & 4ZA RTU4ZA	2 x 1 GANG BOX 2 GANG BOX
TROUBLE & 8 ALARM ZONES	ANNUNCIATOR DRIVER MASTER & SLAVE	RTU & 2 x 4ZA RTU8ZA	3 x 1 GANG BOX 3 GANG BOX
4 ALARM ZONES ONLY	ANNUNCIATOR DRIVER MASTER	4ZA	1 GANG BOX
8 ALARM ZONES ONLY	ANNUNCIATOR DRIVER MASTER & SLAVE	2 x 4ZA 8ZA	2 x 1 GANG BOX 2 GANG BOX

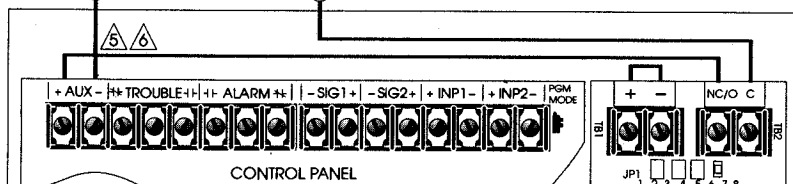
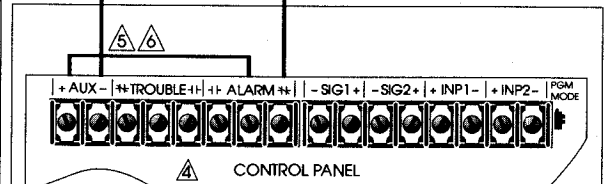
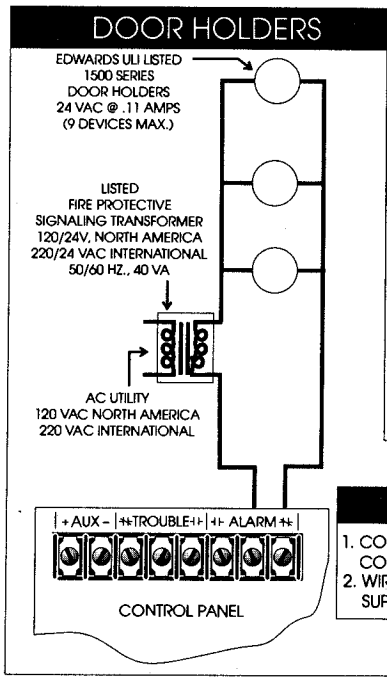
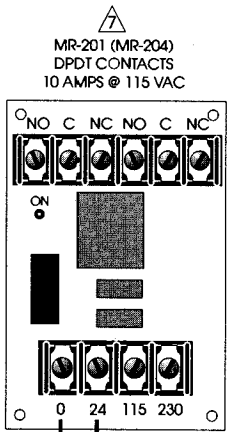
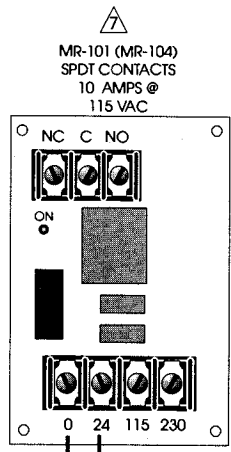

**NOTES**

- CONTACTS SHOWN IN NORMAL CONDITION.
- WIRING RUNS ARE NOT SUPERVISED.

**NOTES**

- FAILSAFE WIRING SHOWN. ANCILLARY RELAYS ARE NORMALLY ENERGIZED AND WILL DE-ENERGIZE ON ALARM.
- USE OF RELAY/CITY-TIE MODULE PROVIDES ENABLE/DISABLE CAPABILITY FOR ANCILLARY RELAYS.
- STANDBY BATTERY CALCULATION REQUIRED. SEE APPENDIX FOR SPECIFIC INFORMATION.
- CONTACT RATING 24 VDC @ 1 AMP.
- AUXILIARY POWER 24 VDC @ 500 mA.
- POWER LIMITED WIRING.
- NON-POWER LIMITED WIRING.
- REFER TO APPENDIX FOR COMPATIBLE DEVICES.
- USE ONLY DOCUMENTED APPLICATIONS.
- WIRING IS SUPERVISED FOR SHORTS AND GROUND FAULTS.



### BATTERY CABINET DIMENSIONS

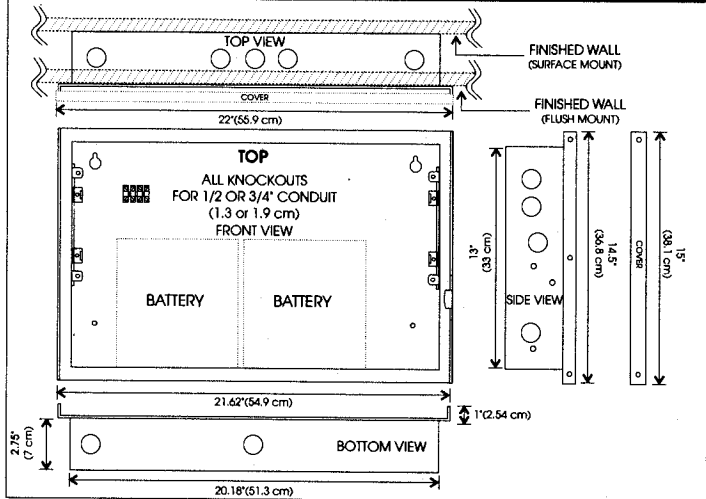

### BATTERY CABINET LOCATION

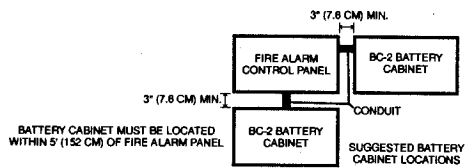

### BATTERY CABINET WIRING

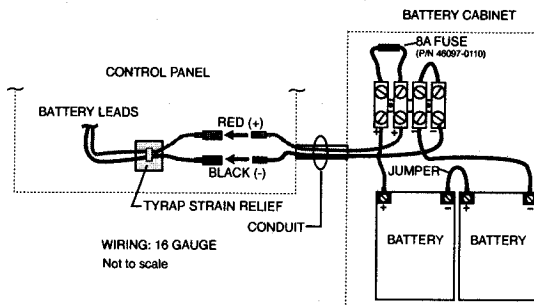

### BATTERY CABINET INSTALLATION

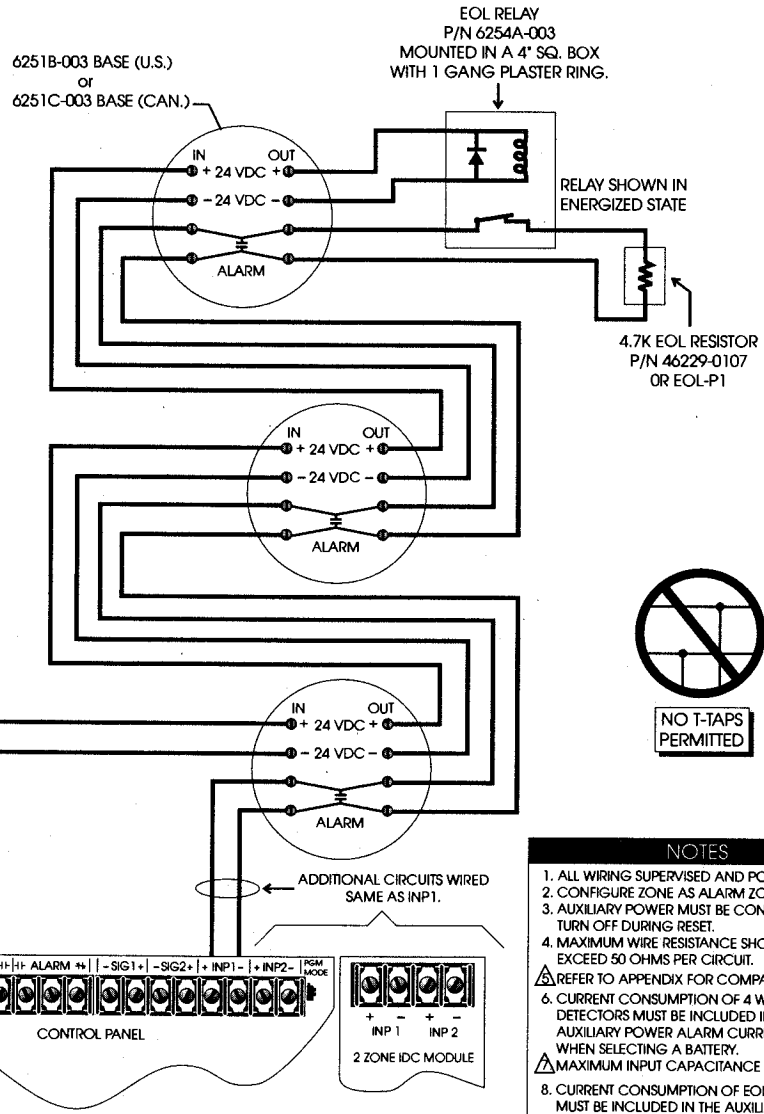

### STYLE B (CLASS B) 4-WIRE SMOKE DETECTOR WIRING

## MULTIPLEXED PROPRIETARY STATION WIRING

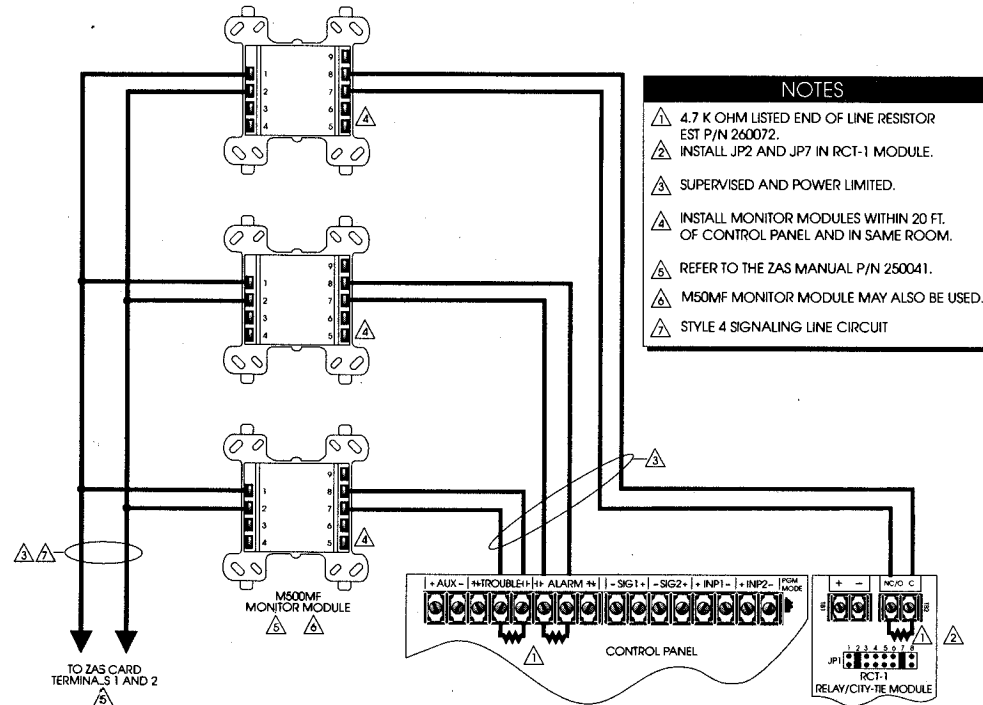

## HARD WIRED PROPRIETARY STATION WIRING

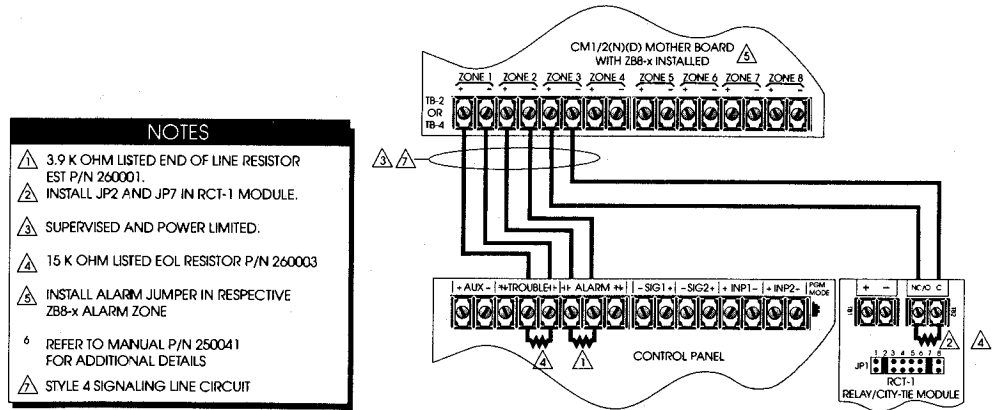

**PROGRAMMING TEMPLATE ON REVERSE SIDE OF FRONT PANEL INSERT**

**STEP 1**

**A** SET PROGRAM MODE SWITCH TO ON. TROUBLE SIGNAL BEEPS.

**B** PRESS **RESET**

**C** POWER LED DISPLAYS 1-PHASE FLASH.

**D** ALL ZONE TROUBLE (YELLOW) LEDS LIGHT WHEN MODULE IS RECOGNIZED BY PANEL PROCESSOR.

**E** PRESS **RESET** TO ADVANCE TO NEXT STEP.

**PROGRAMMING NOTE**  
AT ANY TIME, YOU MAY RESTORE THE FACTORY DEFAULT SETTINGS AND RETURN TO STEP 1 BY PRESSING **RESET** + **RESET**.

**STEP 2**

**A** POWER LED DISPLAYS 2 PHASE FLASH (CONFIGURE IDCs).

**B** SELECT IDC TYPES-

ALARM, NON-VERIFIED	STEADY RED
ALARM, VERIFIED DETECTOR & DRY CONTACT ALARM INITIATING DEVICE	RED ●/●
ALARM, VERIFIED DETECTOR ONLY	RED ●●/●●
SUPERVISORY, N.O. DEVICES	STEADY AMBER
WATERFLOW/SUPERVISORY	STEADY GREEN
WATERFLOW/SUPERVISORY W/ RETARD	GREEN ●●/●●

**C** SELECT SIGNAL CIRCUITS TO BE ACTIVATED BY ZONE. CIRCUIT TROUBLE LIGHTS WHEN SELECTED FOR ACTIVATION.

SIGNAL CIRCUIT 1	STEADY AMBER
SIGNAL CIRCUIT 2	STEADY AMBER
BOTH CIRCUITS	BOTH ON STEADY

**D** PRESS **RESET** TO PROGRAM THE NEXT IDC ZONE AND REPEAT STEPS **B** AND **C** FOR EACH ZONE.

**E** PRESS **RESET** TO ADVANCE TO NEXT STEP.

**STEP 3**

**A** POWER LED DISPLAYS 3 PHASE FLASH (CONFIGURE IACs).

**B** SELECT IAC TYPE. ACTIVE CIRCUIT TROUBLE LED SHOWS TARGET CIRCUIT. ALARM SILENCED LED SHOWS CIRCUIT TYPE.

SILENCÉABLE	AMBER ●●/●●
NON-SILENCÉABLE	OFF

**C** SELECT OUTPUT RATE. IAC TROUBLE LED DISPLAYS ACTUAL OUTPUT PATTERN..

CONTINUOUS	
120 PULSES PER MINUTE	
TEMPORAL (3-3-3)	
CALIFORNIA CONTINUOUS (10 SECS. ON, 5 SECS. OFF)	
CALIFORNIA MARCH TIME (10 SECS. @ 120SPM 5 SECS. OFF)	

**D** PRESS **RESET** TO PROGRAM NEXT IAC ZONE. REPEAT STEPS **B** AND **C** FOR SECOND IAC.

**E** PRESS **RESET** TO ADVANCE TO NEXT STEP.

**STEP 4**

**A** POWER LED DISPLAYS 4- PHASE FLASH (CONFIGURE TIMERS).

**B** SELECT ALARM SILENCE INHIBIT TIMER. ZONE DISABLED LED INDICATES TIMER SETTING.

ALARM SILENCE	NONE	OFF
	1 MINUTE	●●/●●
	2 MINUTE	●●●/●●●
	3 MINUTE	●●●●/●●●●

**C** SELECT AUTOMATIC ALARM SILENCE TIMER. ALARM SILENCED LED INDICATES TIMER SETTING.

ALARM SILENCE	NONE	OFF
	10 MINUTES	●●/●●
	20 MINUTES	●●●/●●●
	30 MINUTES	●●●●/●●●●

**D** PRESS **RESET** TO ADVANCE TO NEXT STEP.

**STEP 5**

**A** POWER LED DISPLAYS 5- PHASE FLASH (CONFIGURE AUXILIARY POWER).

**B** ALARM SILENCED LED SHOWS AUXILIARY POWER RESET STATUS.

ALARM SILENCE	CONTINUOUS POWER	OFF
	INTERRUPT ON RESET	●●

**C** PRESS **RESET** TO ADVANCE TO FINAL STEP.

**STEP 6**

**A** POWER LED IS ON STEADY.

**B** SET PROGRAM SWITCH TO OFF. TROUBLE SIGNAL STOPS BEEPING.

# PANEL OPERATION

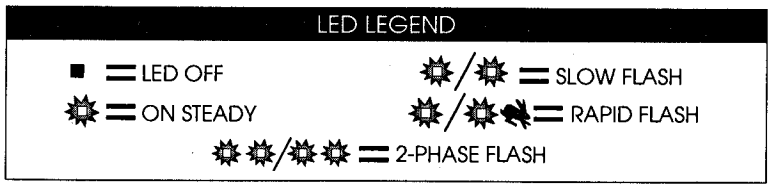
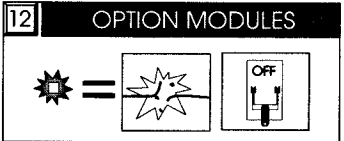
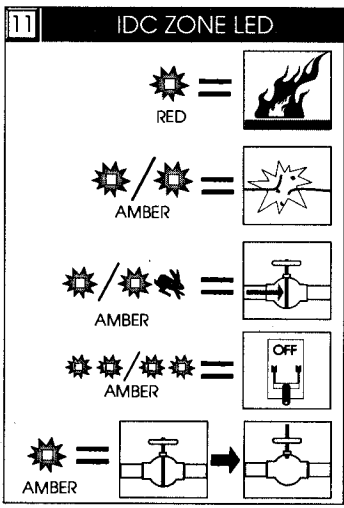
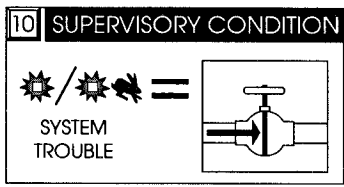
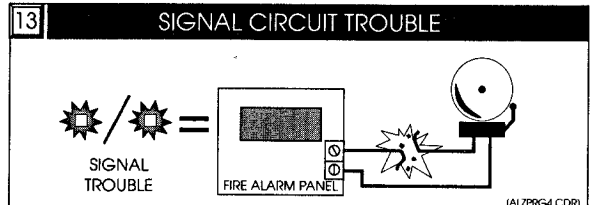
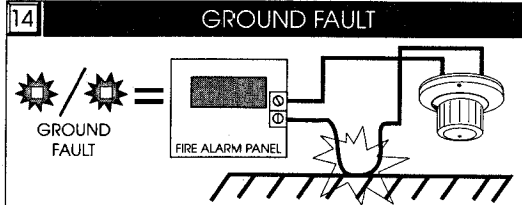
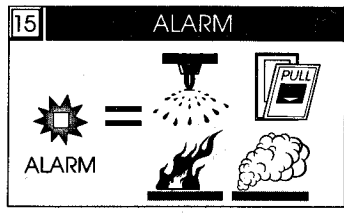
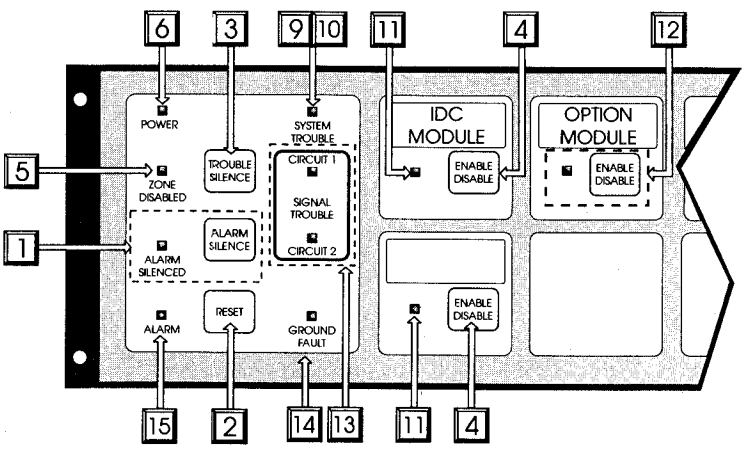
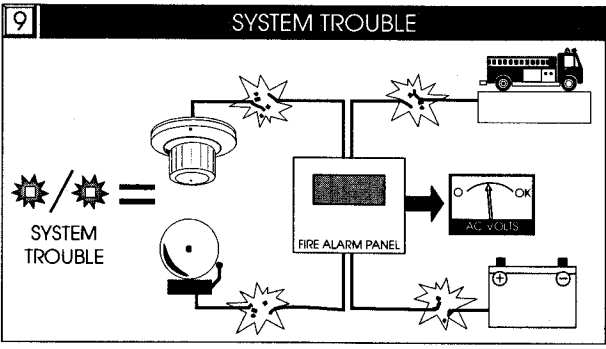
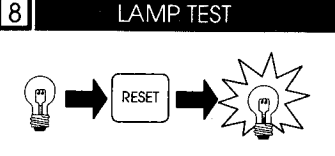
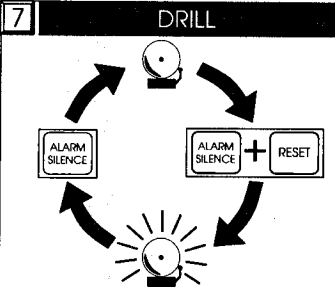
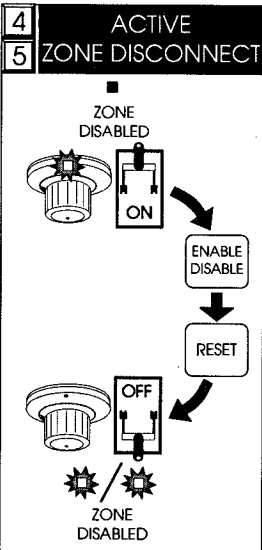
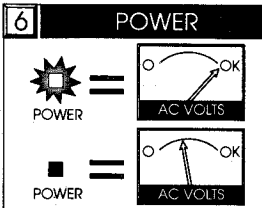
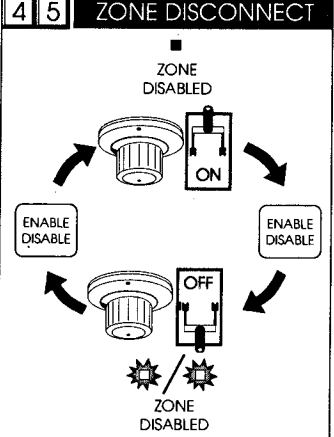
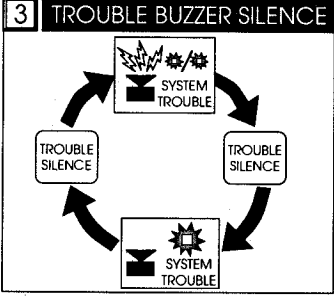
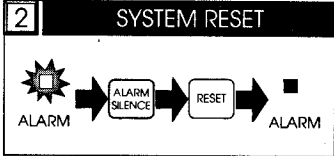
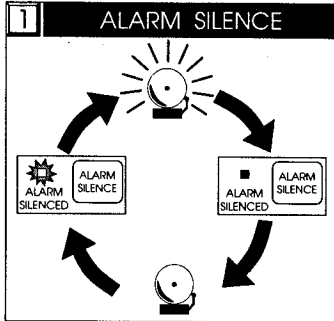

# DIALER OPERATIONS

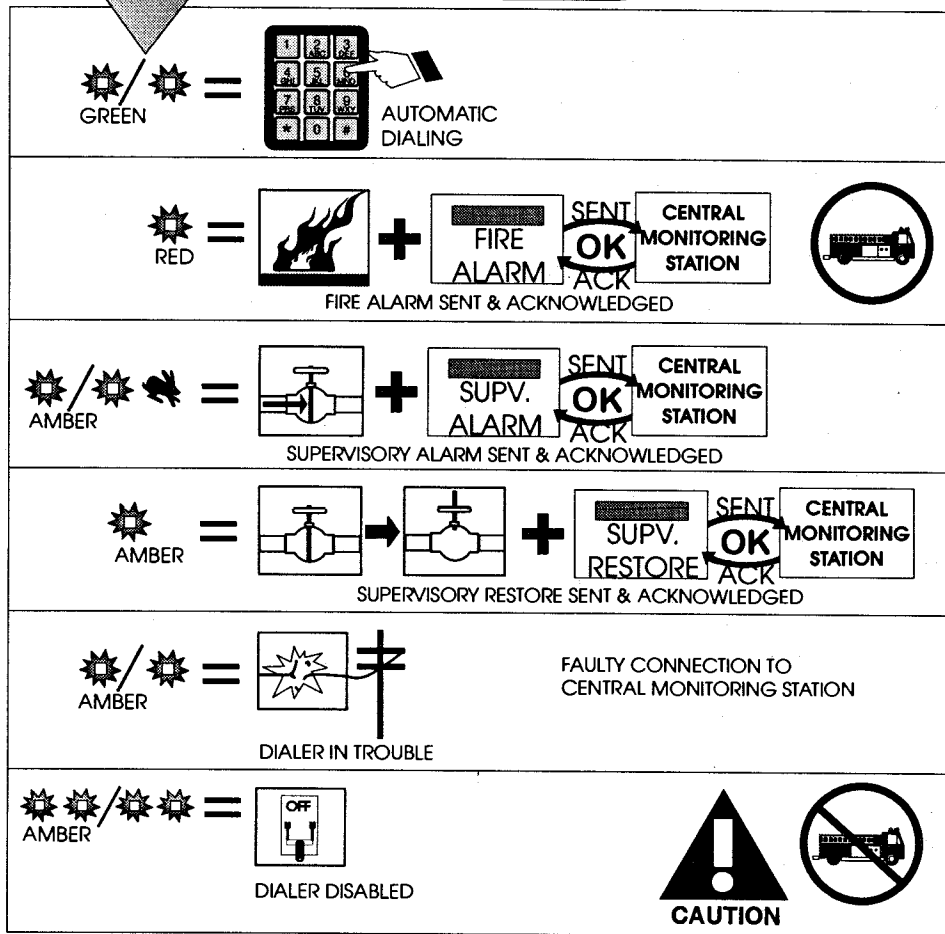
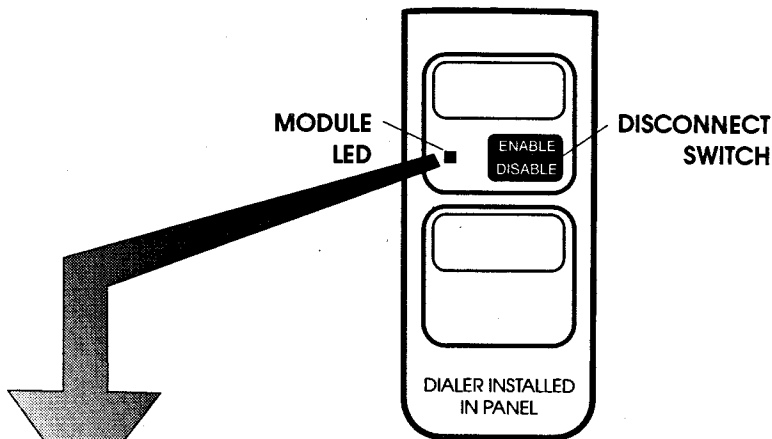

Dialer automatically contacts Central Monitoring Station (CMS) every 24 hours, verifying operation. Dialer will automatically re-enable itself after being disabled for a 24 hour period, and report panel status to the Central Monitoring Station.

## LED LEGEND

- = LED OFF
  - ☀ = ON STEADY
  - ☀/☀ = SLOW FLASH
  - ☀/☀/☀ = RAPID FLASH
  - ☀☀/☀☀ = 2-PHASE FLASH
- RED — LED COLOR